



Issue 18
Spring/Summer 2008

sustain

a journal of environmental and sustainability issues

The
Kentucky Institute
for the Environment
and Sustainable
Development



STUDENT RESEARCH





sustain

Editor

Allan E. Dittmer

Contributing Editors

Russell A. Prough

Russell Barnett

Mark French

John Gilderbloom

Peter B. Meyer

J. Cam Metcalf

David M. Wicks

Craig Anthony (Tony) Arnold

Cover Design

Tim Dittmer

Design/Layout

Nick Dawson

University of Louisville

Design & Printing Services

The Kentucky Institute for the Environment and Sustainable Development (KIESD) was created in July 1992 within the Office of the Vice President for Research, University of Louisville.

The Institute provides a forum to conduct interdisciplinary research, applied scholarly analysis, public service and educational outreach on environmental and sustainable development issues at the local, state, national and international levels.

KIESD is comprised of eight thematic program centers: Environmental Education, Environmental Science, Environmental Law, Sustainable Urban Neighborhoods, Pollution Prevention, Environmental and Occupational Health Sciences, Environmental Policy and Management, and Environmental Engineering.

Sustain is published semi-annually by the Kentucky Institute for the Environment and Sustainable Development, University of Louisville, 203 Patterson Hall, Louisville, Kentucky 40292.

Send electronic correspondence to r.barnett@louisville.edu



This Publication is printed on recycled paper.

UNIVERSITY OF LOUISVILLE

- 2** Ideas to Action Patricia Payette
- 3** The Forgotten Forest: The Ecology and Societal Benefits of Highway Forests T.L.E. Trammell¹
- 10** The Youth Food Diary Project: Understanding Eating Habits, Patterns and Preferences of Middle School-Age Youth in Urban Food Deserts Angelique C. Perez²³
- 22** Photovoltaic Street Lights in Louisville, Kentucky Maria Dawson^{*}
- 28** Understanding the Impact of Asthma Among School-Aged Children Maisah Edwards¹⁷
Janelle Lefebvre²¹
- 32** Mercury Regulation: The Clean Air Mercury Rule in Kentucky Caroline Chan⁸
- 40** Physical Activity and Classroom Behavior Jeanne M. Cundiff¹⁶
Rachel Knecht^{*}
- 46** Environmental Education and Academic Achievement in Elementary School Children James M. Edlin²²
- 49** Comparison of Daylighting Devices for Use in Jefferson County Public Schools Eric Biebighauser⁷
- 54** Investigation of Methods for Proper Stormwater Management on the University of Louisville Campus Justin Faith¹², Robert Lucas¹⁰,
Grace Kim¹¹, Kathleen Marshall⁹,
Kim Nelson¹⁵, Carol Patel¹⁴, Marcus Siu¹³
- 64** University of Louisville Student Food Survey Joshua Porter⁶,
D. Westley Miller², Tyler Lloyd⁵,
Samantha Colvin⁴, Lee Young³
- 72** Creating Sustainable Outdoor Education Programs Melissa Cottrell¹⁹,
Jennifer Hambley¹⁸,
Lindsey Joyce²⁰

1	2 3 4 5 6	7	8
9 10 11 12 13	14 15	16	17 18 19 20
		21	22
24			

Issue 18 Spring/Summer 2008

Cover Photos: Featured Student Authors

*Not Shown

Waterfront Park in Louisville, Kentucky²⁴



Ideas to Action

Patricia Payette, Executive Director of Ideas to Action

What does higher education in the 21st century look like? This issue of *Sustain* illustrates one the recent seismic shifts in academia of the past two decades : teaching and learning is no longer exclusively happening in traditional classroom or lab settings. Students at all levels and in all disciplines are now—more than ever—engaging with the world around them in order to raise pertinent, pressing questions and contribute to research and scholarship for the benefit of diverse sectors of our global society.

At the University of Louisville and at our peer campuses, undergraduate students are finding that original inquiry and research projects are not just for faculty and graduate students anymore. When faculty and administrators make room in their classrooms and curricula for meaningful community engagement, and provide students with the tools, resources and mentorship to succeed, students can rise to the occasion. When exposed to the rewards of asking complex questions, searching out solutions, and applying theories and concepts in the “real world,” students frequently report a sharp increase in their feeling of self-efficacy and a renewed excitement about learning. The rich benefits of campus and community engagement are not only available to students; these collaborations also enrich the lives of off-campus partners and support the missions of non-academic organizations. Environmental issues lend themselves to engaged scholarship: the issues are often complex, interdisciplinary, and relevant to student interests. In its latest strategic plan, the University of Louisville recently renewed its commitment to outreach and engagement by describing itself as a “model metropolitan university, integrating academic excellence with civic engagement to transform Louisville and Kentucky.”

Experiential learning—in which direct experience becomes the platform upon which new understandings and awareness are built—is considered an important complement to academic learning for its potential to permanently transform students’ worldviews. Last year, U of L took an active and important step in guiding all undergraduate students toward educational experiences that foster engagement and complex problem solving when it launched its quality enhancement plan (QEP). In 2005, the Southern Association of Colleges and Schools (SACS) asked U of L to propose a QEP to improve student learning. The initiative had to be practical and one with measurable success. With input and support from all segments of the U of L community, the initiative was created and named Ideas to Action: Using Critical Thinking to Foster Student Learning and Community Engagement, also known simply as I2A.

I2A is designed to sharpen the University’s existing focus on building students’ critical thinking skills, starting in the general education program and continuing through undergraduate major courses. All undergraduate students will have an opportunity to demonstrate their critical thinking skills before they graduate by engaging in a culminating experience, such as a thesis, service learning project, internship or capstone project. Choosing critical thinking and culminating experiences as the heart of I2A reflects UofL’s purposeful commitment to guiding students in “connecting the dots” across the curricula and community. “Connecting the dots” means that we—as faculty and staff—are shaping an environment in which students are encouraged and supported in taking an active role in constructing new knowledge. It requires that the decisions we make about our work as an institution and as individuals are purposeful, intentional and complementary. “Connecting the dots” means that we are using a common vocabulary for teaching and assessing critical thinking. It means that we help students perceive the explicit links between disparate courses and disciplinary concepts.

Helping students “connect the dots” between classes, between campus and community, and between theory and practice, doesn’t imply that we are asking them to draw a one-dimensional representation of reality. When we help students grapple with contradictory evidence or consider multiple theories within a single discipline, we guide students in making meaning in a “messy world.” When students take on new research activities with strong mentors, they have the potential to deepen their critical thinking skills around a number of key concepts, including ethical conduct of research and the nonlinear nature of original inquiry. When we allow students to try out abstract theories in real world situations, students discover that all knowledge doesn’t reside in a textbook ; they see that insight and wisdom can come from themselves and their peers.

As this issue of *Sustain* attests, students are ready and willing to engage in original research projects. Creating new knowledge can be a transformative experience for young scholars. Ideas to Action is just one way the University of Louisville is laying the groundwork for nurturing future scholars and change agents who will ask relevant questions , persist in uncovering answers, and propose solutions to serve and sustain the vital connections between campuses and community.

The Forgotten Forest: The Ecology and Societal Benefits of Highway Forests

T.L.E. Trammell
Department of Biology
University of Louisville



Introduction

Cities, the most human-dominated of all ecosystems, are centers for commerce, cultural innovation, and social diversity. However, there are unintended negative consequences of centralized human activities, such as high rates of energy consumption, concentrated waste production, and introduced invasive species. While anthropogenic activities can be harmful to the environment, natural areas within urban environments counteract or reduce many of the negative effects of concentrated human populations (Carreiro 2008). The phrase 'ecosystem services' refers to the conditions and functions that natural components of ecosystems provide human societies (ESA 1997) via enhanced quality of life, resource availability, and environmental cleansing. Natural ecosystems provide services, such as pollutant filtration, carbon sequestration, waste assimilation and breakdown, noise reduction, rainwater drainage and native species preservation, all of which sustain the human population physically, psychologically, and economically (Bolund & Hunhammer 1999). Humans are an integral part of ecosystems, and the services nature provides are in turn vital to human well-being (Millennium Ecosystem Assessment 2005).

The energy and material required to construct and maintain urban infrastructure and to sustain people makes urban areas 'hotspots' of fossil fuel use and emissions, as well as concentrating magnets for food and materials from around the world. As a result, cities have enormous impacts on environmental quality from local to global scales. Mobile sources of pollution, vehicles, consume a large proportion of fossil fuel use in cities (BTS 2004). Thus, combustion product concentrations are likely to be very high near roads, particularly highways and interstates. Despite their small area, natural and semi-natural areas located adjacent to roadways are well situated for providing a disproportionately large benefit to society by removing some of these pollutants near their source. Vegetation alongside highways is often narrow and linear in urban-suburban landscapes. Because of this high edge-to-interior ratio and proximity to a pollutant source, highway vegetation may be effective barriers and filters to vehicular pollutant movement across urban and suburban landscapes. Trees are particularly important in performing these filtration roles, because they have larger canopies than other perennial plants. Not only are they more efficient at scrubbing noxious air pollutants like particulate matter

and nitrogen oxides (NO_x) from the air, but due to their long-lasting woody tissues trees are also more effective at storing and sequestering the large amounts of carbon dioxide (CO_2) produced from fossil fuel combustion. While CO_2 at ambient concentrations is not toxic to people or wildlife, it is a greenhouse gas that needs to be reduced at the global scale in order to slow the rate of climate change.

While many studies of environmental conditions (deposition of lead and de-icing salt) along roadsides have been conducted, to my knowledge no published studies have quantified the air pollutant capture, and carbon storage and sequestration of woody vegetation adjacent to highways. These understudied wooded verges alongside highways and interstates are 'forgotten forests' in urban areas and across the landscape. Studies of the multiple ecosystem benefits provided by vegetation in cities, particularly highway wooded verges, are important to initiate so that their ecosystem service values can be expressed in monetary terms, and thus inform management and planning (Chen & Jim 2008). Before these values can be quantified, however, the present condition of woody plant communities alongside highways must be described and quantified. Such ecological information can then be used to predict their ability to regenerate and maintain themselves. In addition, the internal ecosystem processes that sustain these habitats need to be measured so that the potential of these wooded habitats to provide ecosystem services into the future can be gauged.

One of the goals of my research is to provide information to urban planners and managers as to which native species might not only best withstand highway conditions in the short term, but also successfully reproduce in these habitats with minimal additional management. The study of vegetation production (new growth per year) will provide information on the ability of soils and woody plants in these highway verge habitats to store and sequester carbon, as well as their potential to filter and modify pollutants. In this article, I describe the interactive effects that different highway pollutants may have on urban forests in general, provide examples of ecosystem services performed by urban vegetation, and present preliminary data on highway forests in Louisville, KY, by specifically focusing on how introduced species may be affecting the ability of these forests to provide societal benefits in the future.



Factors Affecting Urban Forests

Forests alongside highways are influenced by abiotic (e.g., temperature, pollution) and biotic (e.g., exotic species) factors that affect their species composition, and subsequent ecosystem processes, like plant productivity and nutrient cycling. It has long been recognized that urban environments are warmer on average than the surrounding landscape, a phenomenon termed the 'urban heat island' (Bonan 2002). The urban heat island is associated with lengthening of the growing season, which may increase aboveground vegetative growth. On the other hand, warmer urban temperatures also stimulate ozone formation in the lower atmosphere (Botkin & Beveridge 1997), thus reducing plant growth. Urban environments experience elevated carbon dioxide (CO₂), nitrogen oxides (NO_x), ozone (O₃) and other air pollutants in the atmosphere (Gatz 1991), some which are nutrients, and others which are harmful to plants. While nitrogen oxides, NO and NO₂, either singly or in combination with O₃, may depress plant growth, some studies indicate that NO₂ may stimulate plant growth (Wellburn 1990). Some pollutants (CO₂, nitrate and ammonium in rainfall or particulate form) may fertilize trees, while others may cancel out each other's effects (elevated CO₂ can reduce the damaging effects of O₃ since leaf openings (stomates) narrow when exposed to elevated CO₂; Volin et al. 1998). It is not well understood how these multiple factors affect vegetative growth and condition in any one growing season, and this makes understanding the net effects of urban atmospheres and highway conditions on tree growth complicated and difficult.

Biotic factors, such as competition, herbivory, predation and mutualisms among plant, animal and microbial species will also affect forest communities, and all of these factors are altered in urban and suburban settings as compared to rural forests. Native plant species richness and diversity has decreased in many cities, possibly due to exotic plant species encroachment (Drayton & Primack 1996, Gurevitch & Padilla 2004). Investigation of plant species composition provides valuable knowledge as to how forest habitats in cities are responding as a whole system to a myriad of novel urban conditions. Knowledge of plant species composition, in turn, allows us to estimate the societal benefits these forests currently provide and predict how long they will continue to do so in the future.

Ecosystem Benefits Provided by Urban Forests

Many studies by Nowak and McPherson have quantified the value of trees in removing pollutants from the air and reducing energy costs for home cooling in the summer via the shade they provide (Nowak et al. 2002, McPherson et al. 1997, McPherson et al. 2005). Chicago's urban forest removed 2000 metric tons of ozone yr⁻¹ and 1840 metric tons of particulate matter yr⁻¹ (McPherson et al. 1997). For each tree planted in Chicago, a net benefit (benefit minus planting and maintenance cost) of \$402 per tree is provided to local residents (McPherson et al. 1997). Philadelphia's urban trees removed 1084 metric tons of air pollutants yr⁻¹, improving air quality by as much as 3% (Nowak et al.

1997). Since trees can filter up to 70% of the air pollutants emanating from streets (Bolund & Hunhammar 1999), maximum air quality benefits could result from trees located where pollutant concentrations are highest (McPherson et al. 1997). Therefore, woody vegetation may play an important role in the urban landscape by acting as a sink for fossil fuel emissions (N: Ammann et al. 1999, Saurer et al. 2004; C: Dongarra & Varrica 2002) and improving air quality for urban residents.

In addition to their ability to take up air pollutants, woody plants in urban greenspace play an important ecological role in storing and sequestering carbon (C) (Jo & McPherson 1995) and reducing the concentration of CO₂ (an important greenhouse gas) in the atmosphere. Forest regrowth following disturbance is the primary cause of C removal from the atmosphere and C accumulation in the eastern U.S. (Caspersen et al. 2000). However, this C storage annually sequesters only 10-30% of the C released from fossil fuel combustion (Houghton et al. 1999). Thus, identifying areas, like open space along highways with elevated CO₂ concentrations, could improve the total C sink potential in cities. Planting tree species identified as fast growing and pollutant-tolerant alongside highways can further improve the C sequestration potential of highway corridors, which may be prime locations for providing C credits for industries attempting to offset C emissions.

Forest Sites alongside Louisville Interstates

The Louisville metropolitan area has three interstate highways that extend northeast (I-71), south (I-65), and east (I-64) from the city center (in Jefferson county), providing three replicates for research on highway forests. Surrounding land cover (e.g., woody vegetation, impervious surfaces) and land use (e.g., residential, institutional, commercial, parks, vacant) are likely to be strong determinants of the amount of vegetation cover adjacent to these urban highways in Louisville. Impervious surface coverage provides information about the amount of built space and thus the amount of space that may be available for future tree plantings (inverse of impervious surface cover), and vegetation coverage identifies how much vegetation (tree and shrub) cover is already adjacent to the highway. While impervious surface and vegetation cover are proxies for plantable space and the potential need for tree planting, land use analysis will directly provide information as to the activities on the land, which can be used to identify open area or vacant land for future tree planting. I analyzed each interstate using Geographic Information Systems (GIS) and data provided by LOJIC (Louisville and Jefferson County Information Consortium) to obtain initial estimates of how much forest, impervious surface, and open space (vacant lots) is adjacent to each interstate (Figure 1). LOJIC maintains extensive spatial maps and aerial photographs of the metropolitan area and has digitally drawn woody vegetation (tree and shrub area) and impervious surfaces (e.g., buildings, roads) in the county from aerial photographs taken in 2003. I used these GIS layers to explore relationships between land cover types and found, as expected, that I-65 has the most impervious surface cover and the least vegetation



cover, while I-71 has the lowest impervious surface cover and the most vegetation cover (Figure 2). I also analyzed differences between land cover and daily traffic density (KYTC 2004), a surrogate for pollutant load, to identify plantable space in locations with likely higher pollutant concentrations. I found that I-65 has the highest traffic density and the lowest vegetation cover, whereas I-71 has the lowest traffic density and the highest vegetation cover (Table 1). Analysis of land use along these three interstates demonstrated that the land use classified as ‘vacant and undeveloped’ is a substantial proportion of the land use adjacent to all of these interstates (I-65 – 35%, I-64 – 43%, and I-71 – 39%), which may be potential areas available for tree plantings regardless of whether the property is in public or private domain. Identifying open areas for tree plantings along these interstates, especially I-65, which has the highest traffic density and the lowest vegetation cover, may substantially improve vegetation cover and subsequent ecosystem services particularly to residents nearest the road.

To quantify ecosystem service potential of these wooded highway verges, data must be obtained on plant species, and their vegetation structure (density and height of woody plants). To accomplish this, I established twenty-one, 100-m² plots alongside I-65, I-64, and I-71 near the city center to the outskirts of the county. Each plot contained a vegetation canopy that was at least 20-m wide and met the accessibility requirements of the Federal Highway Administration, Department of Transportation (Figure 3). At each site, all woody vegetation was identified and size structure of tree and shrubs determined. One of my findings after analyzing these data was that an exotic, invasive shrub species, Amur honeysuckle (*Lonicera maackii*), was the primary factor explaining variation in vegetation characteristics among all the wooded plots alongside these three interstates. In this article, I will primarily focus on a comparison of highway forests with substantial Amur honeysuckle presence with highway forests that contain low-density honeysuckle. The potential impact of this exotic shrub on the current and continued ability of these wooded verges to provide ecosystem services to society is also discussed.

Differences between highway forests with low and high honeysuckle density

To illustrate representative patterns from across all plots on all three interstates, I present detailed information obtained from two typical contrasting plots along I-64 (one dominated by honeysuckle, and the other not, hereafter referred to as high and low-density honeysuckle sites; Figure 3). I operationally defined high-density honeysuckle plots as having > 70 honeysuckle stems and honeysuckle importance value (IV) > 80 (Table 2). Of the 21 plots I randomly selected, 38% were in the high-density category, and 62% had low-density honeysuckle. The high-density honeysuckle plot not only had higher *Lonicera maackii* stem density and importance value compared to the low-density site, but it also had lower species richness (the number of different tree and shrub species), lower tree basal area (total m² of trees



Figure 1. Woody vegetation alongside Interstate 64 provides habitat for wildlife, reduces noise and air pollution to residential neighborhoods nearby, and reduces our global carbon footprint. Photo courtesy M. Carreiro.

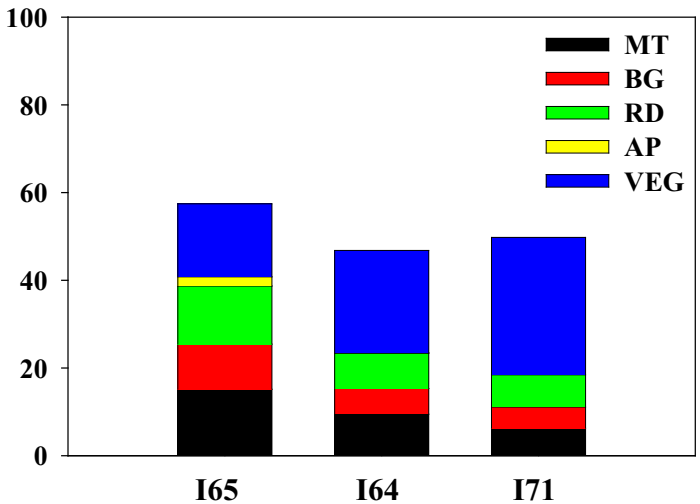

Figure 2. Percent cover by vegetation (shrubs and trees) and impervious built surfaces within a 0.5 km wide transect belt along each interstate. (MT - miscellaneous transportation, BG - buildings, RD - roads, AP - airports).

Highway	Road Length (km)	Traffic Density (cars km ⁻¹ d ⁻¹)	% Vegetation Cover
I-65	21.44	52,406	16.6
I-64	13.37	29,129	23.4
I-71	18.21	14,162	31.3

Table 1. Percent cover of vegetation within a 0.5 km wide transect along the entire length (urban center to Jefferson county boundary) of three interstate highways in Louisville, KY. Traffic density data source: Kentucky Transportation Cabinet (KYTC 2004).

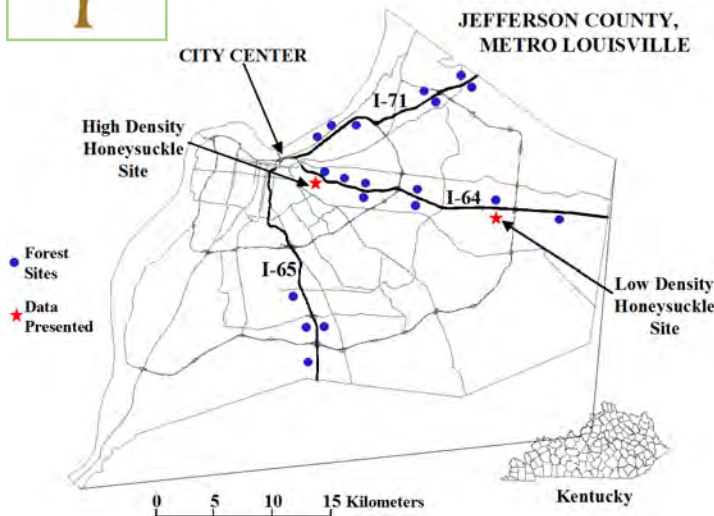

Figure 3. Map of Jefferson county, metro Louisville, showing location of I-64, I-65, and I-71 forest plots (denoted by blue circles). The two representative high-density (HH) and low-density (LH) honeysuckle sites described in this article are denoted by red stars.

obtained by measuring diameter at breast height for each tree), lower tree seedling density, and higher percent exotic tree presence (using relative abundance of adult trees; Table 2). The data shown from these two contrasting plots are characteristic of all high and low-density honeysuckle plots that I established along the three Louisville interstates (Table 2). Therefore, honeysuckle presence may significantly reduce native tree regeneration as evidenced by diminished total seedling germination and higher proportion of exotic tree species abundance in high-density honeysuckle sites (Table 2). Reduced seedling numbers in the high-density honeysuckle plots suggests that tree species are not successfully reproducing in these woodlands, and therefore future adult tree abundance will be low and tree species composition altered.

The diversity of the tree community structure can be shown by graphing the relative abundance of each tree species in order of highest to lowest abundance (rank) (Figure 4). Rank-abundance curves allow a visual comparison of species diversity between sites (the total tree species richness is shown on the x-axis and relative abundance of each tree species on the y-axis). While the high and low-density honeysuckle sites along I-64 have similar tree species richness (5 vs. 6 species, respectively) and community evenness among the tree species (relative abundance of each species, demonstrated by the slope of each line) (Figure 4), their absolute abundance (basal area) (Table 2) and their species composition differ greatly. The high-density honeysuckle site has 62% lower tree cover as measured by basal area and 47% fewer individual trees as adults and saplings (trees < 2.54 cm diameter at breast height and > 1 m height). The second most abundant species in the high-density honeysuckle site is another exotic species, the Tree-of-Heaven (*Ailanthus altissima*) (Figure 4). Sugar maple is the third most important tree species in both sites. My research has shown that in the last few years this species has been reproducing successfully along these highways. Sixty two percent of all the tree seedlings were sugar maple among all the highway plots. However, while sugar maple seedlings were observed in the high-density honeysuckle plots, their absolute abundances were 99% lower than in the low-density honeysuckle plots. This suggests that the ability of these woodlands to provide ecosystem benefits may be reduced in the future unless adaptive management steps are taken to remove honeysuckle and perhaps to plant tree seedlings.

In addition to quantifying the structural (vegetation composition) differences between the high and low-density honeysuckle plots, it is also important to determine whether ecosystem processes may differ between these sites. For example, biomass and leaf area of canopy leaves are used as proxies for estimating primary productivity and canopy size, and hence the ability of the

stands to grow and capture pollutants. As expected, honeysuckle leaf biomass is much higher in the high-density honeysuckle (HH) site than in the low-density honeysuckle (LH) site (92.3 vs. 1.9 g m⁻², respectively; Figure 5A). Whereas leaf biomass of all other species combined is much lower in the HH site compared with the LH site (148.2 vs. 440.0 g m⁻², respectively); hence, *total* foliar biomass was also lower in the HH site (Figure 5A). The foliar biomass of all other species combined (i.e.,

Site	Distance from City Center (km)	Honeysuckle (HS)		Species Richness (per 100m ²)	Basal Area (m ² ha ⁻¹)	Tree Seedling # (per 100m ²)	% Exotic Trees
		HS Stem density	HS IV				
HH	5.47	81	98.8	13	31.1	2	62.5
LH	21.57	30	31.1	24	82.8	765	0
mean HH	N/A	183 ± 24	98.6 ± 1	10 ± 1	43.7 ± 9.0	13 ± 5	19.7 ± 10.4
mean LH	N/A	34 ± 9	43.7 ± 9	20 ± 1	47.8 ± 6.3	302 ± 88	1.1 ± 0.9

Table 2. Vegetation characteristics for high (HH) and low (LH) density honeysuckle sites (100 m² each) located along I-64 in Jefferson County. The mean of each vegetation characteristic of eight high (mean HH) and thirteen low (mean LH) density honeysuckle sites in all three interstates is also shown (± S.E.). Honeysuckle (HS) stem density is expressed on a per hectare (ha) basis. Honeysuckle Importance Value (IV) represents the relative honeysuckle density and relative density of honeysuckle stems > 2 meters high (HS IV = ((relative stem density) + (relative honeysuckle stem density > 2 m height)) * (100/2)). Species richness represents the total number of tree and shrub species per 100 m² plot. Percent exotic trees calculation is based on the relative abundance of adult trees that are not native to KY. 1 hectare (ha) = 10,000 m² or 2.47 acres.

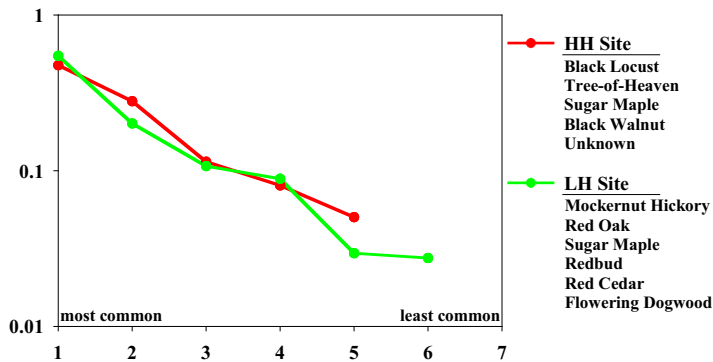

Figure 4. Rank-abundance curve shows the relative abundance (y-axis, proportion of total species) of each tree species (adult trees and saplings) by their rank abundance (x-axis, most common species to least common species) along I-64. relative abundance for each tree species is based on important value (IV) represented by relative frequency and relative basal area (Tree IV = ((relative frequency) + (relative basal area)) * 0.5). Please note this is a semi-log plot, where the y-axis is a logarithmic scale. Tree species (common name) in high and low-density honeysuckle sites are listed in descending order of dominance.

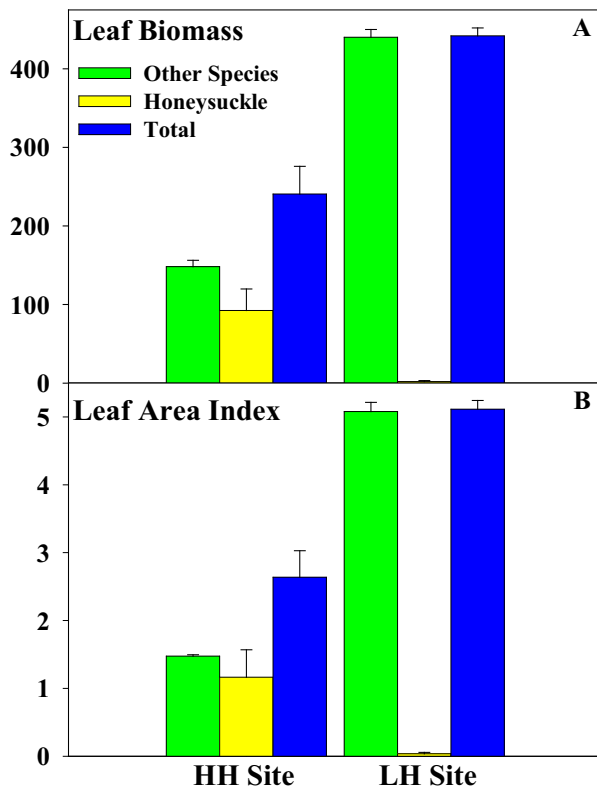

Figure 5. Total, all species combined, and honeysuckle mean leaf biomass (A) and leaf area index (B) (\pm S.E.) is shown. Leaf biomass (A) and leaf area index (B) are shown for the high vs. low-density honeysuckle sites (HH vs. LH).

not including honeysuckle leaves) comprised 62% of the total biomass in the high-density honeysuckle site versus 99.6% of total biomass in the low-density honeysuckle site. This suggests that the ability of trees and other shrub species to grow new leaf biomass has been greatly reduced in the high-density honeysuckle site. As a result, less total carbon can be sequestered at the stand level and less air pollution removed in woody verges dominated by shrub honeysuckle.

Another measurement that relates vegetation to ecosystem services is the Leaf Area Index (LAI, total canopy leaf area per ground area). LAI is positively related to the ability of vegetation to filter pollutants from the air, because the higher the value, the more leaf surface area exists for pollutants to adhere to or be absorbed. Differences in LAI between the plots dominated or not dominated by honeysuckle suggest that total pollutant filtration may be less in the high-density honeysuckle site (2.6 vs. 5.1 m² leaf per m² ground in the high vs. low-density honeysuckle sites, respectively; Figure 5B). However, in the high-density honeysuckle sites more pollutant capture may occur lower down in the canopy, since honeysuckle leaves comprise 44% of the total LAI in the high-density honeysuckle site as compared to 1% in the low-density honeysuckle site. The differential height structure in these woodland communities may be important when estimating pollutant filtration and carbon sequestration, depending on the vertical distribution of pollutant inputs and carbon dioxide as they enter the sites, particularly from the highway side.

Modeling Ecosystem Services

This study has shown that the ecological structure and function of highway forests differs in the presence of Amur honeysuckle, suggesting that the ability of these forests to provide ecosystem services now and in the future is diminished. The Urban Forestry Effects (UFORE) model developed by the USDA Forest Service (Nowak et al. 2003) has been an important tool for measuring the societal benefits derived from trees. Based on measurements of tree identity, height and canopy volume, and citywide average pollutant levels and climate, this model can be used to estimate the pounds of various air pollutants that the tree removes, the amount of carbon stored and its annual carbon storage rate (sequestration), and the energy savings derived from a tree that shades a building, then provides a dollar value estimate for that tree. I have begun to acquire these data for my highway plots and at this writing can compare the carbon storage and sequestration values estimated for the high and low-density honeysuckle sites. UFORE estimated substantially higher carbon storage and sequestration in the low-density honeysuckle site than in the high-density honeysuckle site (Figure 6). This suggests that honeysuckle presence in forests alongside these interstates is associated with a greatly reduced ability to capture and store carbon by reducing forest stand-level LAI. Carbon storage and sequestration in honeysuckle-dominated forests may continue to be reduced, since there is



substantially lower tree seedling regeneration in honeysuckle sites. UFORE output also reports relative ranking of species effects on air quality and species condition, providing information that can be used to evaluate which species are possibly the least sensitive to harmful conditions alongside these interstates. As I continue this UFORE analysis, I intend to identify which tree species may be best for planting alongside Louisville interstates and communicate these findings to land managers and urban planners.

Conclusions

My study of highway forests in Louisville, KY has demonstrated that the most important factor in determining vegetation composition, ecological function, and ecosystem services is the presence of an exotic, invasive shrub species (Amur honeysuckle). Forests that contain significant honeysuckle exhibited lower native

tree regeneration, primary production (as related to LAI), and carbon storage and sequestration. This correlative study strongly suggests that the current and future potential of these highway forests to provide benefits for society are greatly reduced due to invasion by this honeysuckle shrub. Therefore, I strongly urge local residents to remove or avoid planting Amur honeysuckle in their yards, because birds can easily transfer seeds from residential yards to our park and highway forests.

Interstate 64 and 71 have higher honeysuckle densities in sites that are close to downtown Louisville, whereas forests further from the city are dominated by native species and have low honeysuckle densities. Thus, without further experimentation, it is difficult to separate the potential urbanization effects on these highway forests from honeysuckle invasion itself. However, the good news is this shrub has not invaded all sites close to the city. Surprisingly, forested verges along interstate 65 contained very little honeysuckle and consisted primarily of native species, including uncommon, native shrub species. Despite the fact that I-65 has the highest traffic density and impervious surface coverage and probably highest pollutant emissions of the three interstates, stretches of highway still exist that are composed of native forested habitat that appear healthy. These native highway forests deserve management attention for several reasons. Forests with higher native species abundance provided more ecosystem services in the form of carbon sequestration, which is important locally and globally. They remove pollutants from the air, serve as habitat for local species, and serve as corridors for movement of wildlife (Forman et al. 2003). With some management attention and timely removal of invasive species like honeysuckle, these forests can continue to perform these functions for people and other species. Identifying plantable space alongside interstates and highways, followed by a tree planting program of native species best suited to withstand highway condi-

tions may be a wise investment for improving quality of life in urban areas.

To apply my research on the ecology of highway forests to issues of urban sustainability in Louisville, especially on a typically overlooked urban forest, is exciting. These ‘forgotten forests’ are not only our roadside companions, but they also contribute many ecological services to our urban residents. It is my hope that these ‘forgotten forests’, long under appreciated and taken for granted, will be recognized for their value and managed to maximize their benefit to society.

Acknowledgements

I greatly appreciate the encouragement of Dr. Margaret Carreiro and the intellectual and empirical guidance she has provided throughout my graduate education. Thanks also to fellow students Haylee Ralston, Anthony Rietl, Brad Schneid, and Shannon Scroggins, who have assisted with field and laboratory work during this research. I also thank Cary Cassell, Kentucky Transportation Cabinet (KYTC), for his guidance on conducting highway research, and the Department of Highways, KYTC for permission to access the interstate right-of-way. I am also grateful to the Kentucky Society of Natural History, the Kentucky Academy of Science, and the USDA Forest Service NRS-4952 and SRS-4952 for funding.

Tara L.E. Trammell is a doctoral candidate in the Department of Biology. She has received a University Fellowship from the graduate school and a research assistantship from the USDA Forest Service, Northern Global Change Program to conduct her research in Urban Forest Ecology. She received a M.S. in Biology from the University of Louisville and a B.A. in Mathematics from Berea College. Her research interests include mathematical modeling, ecosystem ecology, and urban ecology.

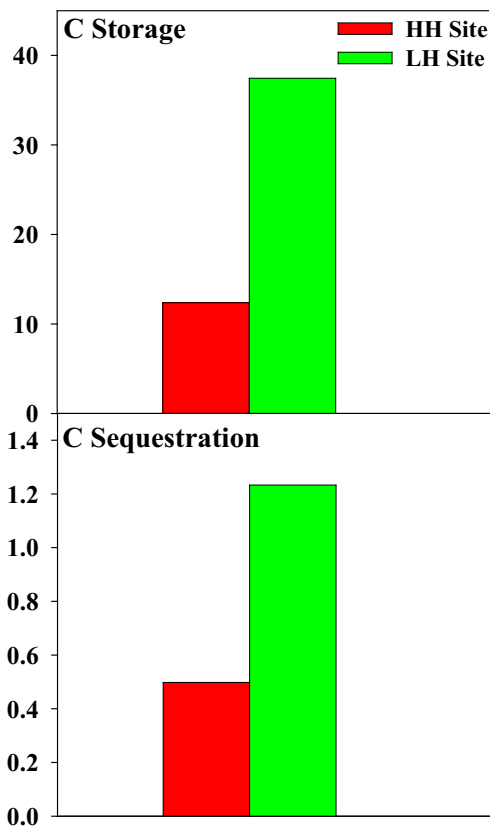
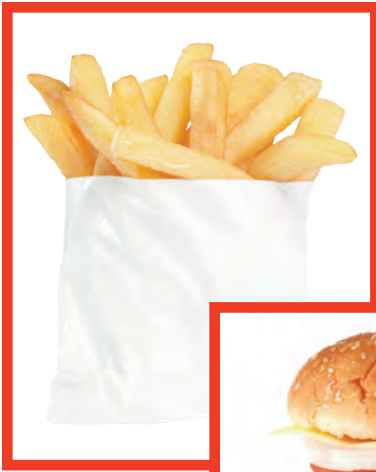

Figure 6. Carbon storage (kg m⁻²) and sequestration (kg m⁻² yr⁻¹) by trees in forests with high (HH) vs. low (LH) densities of honeysuckle along I-64 in Louisville, KY.



References

- Ammann, M., Siegwolf, R., Pichlmayer, F., Suter, M., Saurer, M., and C. Brunold. 1999. Estimating the uptake of traffic-derived NO₂ from 15N abundance in Norway spruce needles. *Oecologia* 118: 124-131.
- Bolund, P., and S. Hunhammar. 1999. Ecosystem services in urban areas. *Ecological Economics* 29: 293-301.
- Bonan, G. B. 2002. *Ecological Climatology. Concepts and applications*. Cambridge, UK, Cambridge University Press.
- Botkin, D. B., and C.E. Beveridge. 1997. Cities as environments. *Urban Ecosystems* 1: 3-19.
- BTS (U.S. Bureau of Transportation Statistics). 2004. *National Transportation Statistics 2003*. Available at: http://www.bts.gov/publications/national_transportation_statistics/2003/.
- Carreiro, M.M. 2008. Introduction: the growth of cities and urban forestry. In: Carreiro, M.M., Song, Y-C., and J. Wu (eds.) *Ecology, planning, and management of urban forests: international perspectives*. Springer, New York, pp. 3-9.
- Caspersen, J.P., Pacala, S.W., Jenkins, J.C., Hurtt, G.C., Moorcroft, P.R., and R.A. Birdsey. 2000. Contributions of land-use history to carbon accumulation in U.S. Forests. *Science* 290: 1148-1151.
- Chen, W.Y., and C.Y. Jim. 2008. Assessment and valuation of the ecosystem services provided by urban forests. In: Carreiro, M.M., Song, Y-C., and J. Wu (eds.) *Ecology, planning, and management of urban forests: international perspectives*. Springer, New York, pp. 53-83.
- Dongarra, G., and D. Varrica. 2002. 13C variations in tree rings as an indication of severe changes in the urban air quality. *Atmospheric Environment* 36: 5887-5896.
- Drayton, B., and R.B. Primack. 1996. Plant species lost in an isolated conservation area in metropolitan Boston from 1894 to 1993. *Conservation Biology* 10(1): 30-39.
- ESA (Ecological Society of America). 1997. *Ecosystem Services: Benefits supplied to human societies by natural ecosystems*. *Issues in Ecology* 2. Available at: http://esa.org/science_resources/issues.php.
- Forman, R.T.T., Sperling, D., Bissonette, J.A., Clevenger, A.P., Cutshall, C.D., Dale, V.H., Fahrig, L., France, R., Goldman, C.R., Heanue, K., Jones, J.A., Swanson, F.J., Turrentine, T., and T.C. Winter. 2003. *Road Ecology. Sciences and Solutions*. Island Press, Washington, DC.
- Gatz, D.F. 1991. Urban precipitation chemistry: a review and synthesis. *Atmospheric Environment* 25B: 1-15.
- Gurevitch, J., and D.K. Padilla. 2004. Are invasive species a major cause of extinctions? *Trends in Ecology and Evolution* 19(9): 470-474.
- Houghton, R.A., Hackler, J.L., and K.T. Lawrence. 1999. The U.S. carbon budget: contributions from land-use change. *Science* 285(5427): 574-578.
- Jo, H-K., and E.G. McPherson. 1995. Carbon storage and flux in urban residential greenspace. *Journal of Environmental Management* 45: 109-133.
- KYTC (KY Transportation Cabinet). 2004. *Division of Planning. Daily Vehicle Counts*. Available at: <http://www.kytc.state.ky.us/planning/reports.shtm>
- McPherson, E.G., Nowak, D., Heisler, G., Grimmond, S., Souch, C., Grant, R., and R. Rowntree. 1997. Quantifying urban forest structure, function, and value: the Chicago Urban Forest Climate Project. *Urban Ecosystems* 1: 49-61.
- McPherson, G., Simpson, J.R., Peper, P.J., Maco, S.E., and Q. Xiao. 2005. Municipal forest benefits and costs in five US cities. *Journal of Forestry* 103(8): 411-416.
- Millennium Ecosystem Assessment. 2005. *Ecosystems and human well-being. Synthesis*. Island Press, Washington, DC. Available at: <http://www.millenniumassessment.org/en/index.aspx>.
- Nowak, D.J., McHale, P.J., Ibarra, M., Crane, D., Stevens, J.C., and C.J. Luley. 1997. Modeling the effects of urban vegetation on air pollution. 22nd NATO/CCMS International Technical Meeting on Air Pollution Modeling and its Application. Clermont-Ferrand, France.
- Nowak, D.J., Crane, D.E., and J.F. Dwyer. 2002. Compensatory value of urban trees in the United States. *Journal of Arboriculture* 28(4): 194-199.
- Nowak, D.J., Crane, D.E., Stevens, J.C., and R. Hoehn. 2003. *The Urban Forest Effects (UFORE) Model: Field Data Collection Procedures*. USDA Forest Service, Syracuse, NY.
- Saurer, M., Cherubini, P., Ammann, M., De Cinti, B., and R. Siegwolf. 2004. First detection of nitrogen from NO_x in tree rings: a 15N/14N study near a motorway.
- Volin, J.C., Reich, P.B., and T.J. Givnish. 1998. Elevated carbon dioxide ameliorates the effects of ozone on photosynthesis and growth: species respond similarly regardless of photosynthetic pathway or plant functional group. *New Phytologist* 138: 315-325.
- Wellburn, A.R. 1990. Tansley Review No. 24: Why are atmospheric oxides of nitrogen usually phytotoxic and not alternative fertilizers? *New Phytologist* 115: 395-429.



The Youth Food Diary Project: Understanding Eating Habits, Patterns and Preferences of Middle School-Age Youth in Urban Food Deserts

Angelique C. Perez, MPH

Introduction

Rates of obesity, overweight and chronic diseases are rapidly rising among adults and young people in the United States, and recent research indicates that the burden of these conditions falls disproportionately on low-income, urban, minority populations. This pattern has prompted an interest in the ways the urban environment influences individual and community health, nutrition, and food access. Social scientists, community groups, nutritionists, and public health and medical professionals are focusing attention on environmental barriers that limit people's access to a healthy diet. This research has elucidated problems of "food insecurity" particularly within "food deserts" found in both rural and urban American communities. In this paper, our concern is with young people in an urban food desert, their eating habits, and ideas about food – in short their "foodways". We report on recently concluded research in Louisville, Kentucky's largest city. Conducted as part of a community food assessment, the Youth Food Diary Project (YFDP) offers a window into the consequences of food insecurity in urban food deserts for middle-school age children.

Defining Terms: Food Insecurity in Urban Food Deserts

The United States Department of Agriculture (USDA) (2000) defines household food security as "access by all people at all times to enough food for an active, healthy life" (p. 6). They define food insecurity as "limited or uncertain availability of nutritionally adequate and safe foods or limited or uncertain availability to acquire acceptable foods in socially acceptable ways" (p. 6). According to the USDA's Economic Research Service (2005) nearly 12 percent of households suffered a lack of access to enough food to live healthfully in 2004 and, among those, 3.9 percent actually lived with hunger (p.4-5). The same USDA report notes that these rates double in Black and Hispanic households, which contributes to persistent health disparities. According to Healthy People 2010 (2000), the U.S. Department of Health and Human Services' Office of Disease Prevention aims

to reduce food insecurity rates by 2010. Unfortunately, this goal seems almost unattainable, as rates have risen rather than fallen in the last several years (USDA 2005).

Promoting access to healthy foods is of paramount importance in public health as a host of health problems have nutritional components. The health consequences of food insecurity are multiple, and include obesity and associated chronic diseases, infant mortality, anemia, and stunted growth. Dietary factors are also associated with developmental delays, poor educational performance and mental wellbeing. A healthy diet serves as an important public health preventive measure, and improves quality of life. In this sense, assuring consistent availability and accessibility of nutritious foods is important to the overall mission of public health: "To assure conditions in which people can be healthy" (Institute of Medicine, 1988).

Household food security depends on access to nutritious foods at the community level or "community food security." Hamm and Bellows (2003) broadly defined community food security as: "A situation in which all community residents obtain a safe, culturally acceptable, nutritionally adequate diet through a sustainable food system that maximizes community self-reliance and social justice" (p. 37). The term "food desert" emerged in the 1990s to describe areas with limited food access where residents faced barriers to consuming a healthy diet. According to Reisig and Hobbiss (2000), the term was popularized in the United Kingdom by the Low Income Project Team, which defined food deserts as "areas of relative exclusion where people experience physical and economic barriers to accessing healthy foods" (p.138). Food deserts are not only physical spaces with geographic barriers to food access, but points of convergence for a variety of obstacles that interact to limit people's consistent access to nutritious food, health and quality of life.

While not solely an urban problem, myriad barriers threaten community food security in urban food deserts across the United States. Eisenhauer (2001) argues that the food desertification of



urban areas, and the erosion of dietary quality and health among the urban poor are intricately linked to historical trends and decision-making processes. Locating eating, nutrition and health patterns among poor, urban populations within historical processes counteracts the idea that the dietary habits of these populations can be explained in cultural or genetic terms. This author turns attention to the trend of “supermarket redlining” in inner city urban areas, noting that the number of supermarkets is declining in the U.S. as major chains transition toward fewer and bigger stores (p. 125). Eisenhower points out that the same chains that once moved into cities and out-priced locally owned food businesses are now pulling out of these urban areas in favor of more profitable suburban locations. This trend deprives the urban poor of access to healthy food and “diminishes potential for health in inner cities” (Eisenhower, 2001, p.125).

At the same time as urban areas experience economic disinvestment, low-income minority populations have become increasingly concentrated in inner-city urban neighborhoods (Eisenhower, 2001, p. 126). With supermarkets and other accessible fresh food retailers absent, these residents are forced to look outside their communities and travel longer distances to purchase groceries. Transportation to supermarkets becomes an issue for income-poor families who are less likely to own vehicles and must walk or rely on taxis or other forms of public transportation, which can be costly, time consuming, unsafe, and unreliable. These difficulties can be compounded by physical barriers such as the absence of streetlights and sidewalks that make walking to and from stores unpleasant and even dangerous. Perceptions of community safety can also limit access to food retailers, as some people may be reluctant to walk or take other forms of public transportation to and from stores. These factors all limit access to healthy diets for residents in low-income urban neighborhoods, and are likely to be exacerbated by other micro-level barriers such as personal mobility, health, cooking knowledge and time constraints. For example, Shaw (2006) notes that “weight carrying capacity” is limited for food shoppers who must walk to and from distant stores. Access to food and health is diminished when personal “weight carrying capacity is already spoken for by essential non-food items” (p. 232).

Food purchasers may negotiate these problems by purchasing less healthy processed and prepared foods that are available closer to home” (p. 232). While the number of supermarkets declines in U.S. cities, the number of fast food restaurants in urban areas has steadily increased. Story, Neumark-Sztainer, & French (2002) note that the number of these restaurants in the United States rose from approximately 75,000 in 1972 to nearly 200,000 in 1997 (p. S46). Convenience stores that offer fewer fresh food items, and charge higher prices than supermarkets have also proliferated in urban areas. Eisenhower (2001) argues that this “lack of access to quality food sources- and thus adequate nutrition- has been a central cause of diminished health among

the urban poor, and that this reduced access has constrained choices and changed behavior over generations” (p.126).

Consequences of Food Deserts for Young People

Food deserts present barriers of access at the community level that limit individual and family access to affordable, nutritious foods. Young people are especially vulnerable to the effects of food insecurity and poor nutrition. By analyzing NHANES III data, Alaimo, Olson, Frongillo, & Briefel (2001) demonstrated that school- and preschool-aged “food insufficient children, in comparison with food sufficient children, were significantly more likely to have poorer health status and to experience more stomachaches and headaches” (p. 784). The CDC advises, “many health-risk behaviors, which contribute to the leading causes of morbidity and mortality among youth and adults, are established during youth and extend into adulthood, are interrelated and preventable” (2004). This is an important time period in growth and development; adolescent health specialists estimate that approximately 50 percent of adult weight is gained during adolescence (Story, Neumark-Sztainer, & French, 2002, p. S42). Rising rates of obesity and overweight and their associated chronic diseases are currently among the most pressing consequences of food insecurity for young people. Health experts generally agree that the prevalence of obesity and overweight have reached epidemic proportions, and research also highlights the fact that rates of obesity are even higher among low-income and minority youth (Crawford, 2006, p.28). Kimm, Gergen, Malloy, Dresser, & Carrol (1990) warn that, “Black children’s dietary patterns are less favorable for cardiovascular health than white children’s” (441). This trend is likely to contribute to persistent health disparities.

In addition to impacting short- and long-term health, food insecurity and poor nutrition also affect children’s educational achievement and development. Schwimmer, Burwinkle, & Varni (2003) point out that severely overweight children miss four times as much school as normal weight children and that obese children and adolescents are four times more likely to report impaired school function than normal weight children (p. 1818). These authors also demonstrate that overweight and obese children and adolescents experience diminished quality of life. A 2001 study, which analyzed data from the Third National Health and Nutritional Examination Survey (NHANES III), indicated 6-11 year old children from food insufficient families were more likely to repeat a grade and attain lower math scores (Alaimo, Olson, & Frongillo, 2003, p. 44). Families were classified as food insufficient if parents reported they did not always have enough food to eat on the NHANES III survey. Brown and Pollit (1996) found that children who suffered from poor nutrition scored lower on vocabulary, reading comprehension, arithmetic and general knowledge tests (p. 38).



Characterizing Youth “Foodways” in Urban Food Deserts in Louisville, KY: The Youth Food Diary Project

The Youth Food Diary Project (YFDP) was one component of a collaborative community food assessment, spearheaded by the Community Farm Alliance (CFA), a statewide grassroots organization working on food security issues in Metro Louisville. CFA drew on suggested assessment methods and devised their own unique strategies to examine Metro Louisville’s local food system and identify factors that affect residents’ access to healthy foods, especially in West Louisville and East Downtown, low-income, economically depressed, inner-city areas.

CFA members sought to incorporate a youth perspective into the food assessment process to understand how the food environment in these inner-city Louisville neighborhoods could impact the eating patterns and health of children. The project originated from the efforts of CFA’s Research Advisory Team, consisting of University of Louisville professors and students, Jefferson County Public Schools personnel, and public health professionals, to develop a project that would offer a learning opportunity to local youth and also provide relevant data for the food assessment. The YFDP entailed working collaboratively with middle-school teachers in Jefferson County Public Schools to provide students with food and nutrition presentations, and food diary and writing assignments that supported the School District’s core content learning and life skill development goals. It also involved collecting and analyzing students’ anonymous food diaries and writing assignments to identify and characterize patterns in their eating habits, preferences and other food related behaviors. This collaborative project offered educational benefits for local students and afforded CFA a means to include children in the community food assessment process.

Background

Louisville Metro, the largest, most urban, and most diverse city in the state of Kentucky is located in Jefferson County, which had a population that neared 694,000 in the year 2000. Following trends noted by Eisenhower (2001) in urban areas across the country, Louisville’s low-income and minority populations have become increasingly concentrated in inner-city neighborhoods in the West Louisville and East Downtown areas. These areas have also experienced economic disinvestment, a loss of fresh food retailers and a high burden of poor health. A recent Health Status Assessment Report published by the Louisville Metro Health Department focused attention on declining community health and on growing health disparities in the city (2005). Following national trends, rates of obesity and overweight, Type II Diabetes, stroke and heart disease are rising most markedly among Louisville’s low-income minority populations. Louisville’s local food environment has gained attention in part because many of the city’s most pressing health concerns have underlying nutritional or dietary risk factors.

CFA’s food assessment provided an opportunity to better understand the local food economy and to generate ideas about how it could be changed to promote health, economic vitality and quality of life. CFA’s assessment effort relied on an ecological and systems approach to nutrition issues. By looking at individual behaviors as informed by broader socioeconomic, cultural and physical environments, the assessment process illuminated a host of barriers to accessing healthy, affordable foods in the West Louisville and East Downtown areas. CFA titled their completed assessment *Bridging the Divide* (2007) because the process revealed a great divide or disparity in terms of the accessibility, quality and affordability of fresh healthy foods between West Louisville and East Downtown neighborhoods and the wider Metro area. These areas are identified in CFA’s assessment report as “food deserts” based on the convergence of several barriers that limit residents’ access to healthy diets. These barriers are:

Poverty

The average median household income in West Louisville is \$20,900 and in East Downtown is \$14,333 (CFA, 2007, p.5). Both these figures are much lower than the county wide average of \$39,457. As described above, income-poor, urban populations face budgetary constraints that affect access to healthy foods. In contrast to fixed budgetary items like rent or energy bills, food stands as one of the more flexible items on poor families’ budgets (Shaw, 2006, p. 232). Families with limited budgets may choose pre-processed or fast foods to save money and time. Budgetary constraints can also limit transportation options to food stores that offer healthier, more reasonably priced food items.

Scarcity of Full Service Grocers

CFA (2007) points out that West Louisville and East Downtown neighborhood residents are drastically underserved by full service grocery stores (p.7). The great majority of supermarkets in the Louisville Metro area lie outside the city’s urban core, and away from West Louisville and East Downtown’s low-income, minority populations (See Figure 1). This local trend is not unique to Louisville, but is represented across the nation, as research has shown that white neighborhoods house four times as many supermarkets as black neighborhoods (Morland, Wing, Roux, & Poole, 2001, p. 27). West Louisville and East Downtown have only half the full service grocers than the city as a whole: the ratio is one grocer per 25,000 residents in contrast to one for every 12,500 residents (CFA 2007, p. 6). This lack of food access is likely to impact residents’ ability to eat healthfully, as access to healthy foods in neighborhoods is associated with residents meeting dietary recommendations and better health status (Morland, Wing, & Diez-Roux (2002).

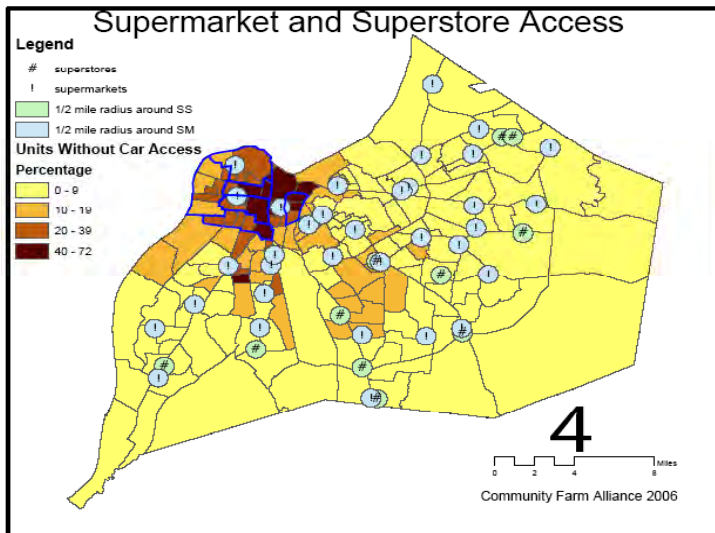

Figure 1. Supermarket and Super Store Access with Household Vehicle Access (CFA, 2007, p. 15). West Louisville and East Downtown residents have access to fewer supermarkets than other residents of Metro Louisville.

Convenience Stores- Higher Prices, Lower Selection and Quality

While underserved by full service grocers, West Louisville and East Downtown neighborhoods are saturated with convenience stores that offer lower quality, higher priced, and less healthy foods. CFA (2007) conducted a market basket survey to compare the price, availability and quality foods at different types of area retailers. They determined that the convenience stores most accessible to West Louisville and East Downtown residents charged more and carried fewer items from the market basket than the average Louisville supermarket (p. 6-9). These stores also rarely stocked fresh fruits and vegetables. By examining 24

area stores, CFA showed that most convenience stores only carry onions and potatoes and fail to offer leafy greens (p. 6). None of the stores they investigated carried food from all five basic food groups, and the produce that was being sold was found to be of poor quality and to be overpriced (p. 6).

Prevalence of Fast Food Outlets

Although affordable fresh foods are hard to find, high fat, energy-dense fast foods are plentiful in these areas (See Figure 2). For example, Broadway Street, a main thoroughfare connecting East Downtown to the West End, had 24 fast food outlets in a 2.8-mile stretch in 2005 (CFA, 2007, p. 11). Although fast food outlets offer less healthy options, residents marooned within food deserts turn to these retailers because they offer affordability and convenience. CFA's assessment points out that even the full service grocers that do exist in these areas are surrounded by fast food. The high concentration of fast food restaurants is likely to translate into higher fat and lower quality diets for local residents. A recent study conducted in Ontario, Canada (2005) found that mortality and admissions for acute coronary syndromes were higher among regions with a greater number of fast food restaurants (Alter, D.A. & Eny, K., p. 175). These authors demonstrated, "Each increase of one fast food outlet per 100,000 people in a region corresponded to an additional one death per 100,000 persons, after adjusting for baseline sociodemographic differences" (p. 175).

Lack of Transportation

Transportation difficulties further compound and limit food access in West Louisville and East Downtown. Living without access to a vehicle is very common in these densely populated areas, so that the residents with access to the fewest number of supermarkets also have the fewest number of drivers. CFA (2007) notes that up to 72 percent of households here, many of which are multi-member, lack access to a single vehicle (p. 13). By contrast, in most parts of Metro Louisville fewer than 10 percent of households lack vehicle access (p.13-14). Public transportation and taxis are costly and time-consuming, and can be unsafe which further exacerbates residents' difficulty accessing fresh foods.

The YFDP focused on West Louisville and East Downtown middle schools because of the factors that converge in these "food deserts" and interact to limit residents' access to an affordable nutritious diet. The lack of access to nutritious foods in West Louisville and East Downtown neighborhoods is likely to be a factor in declining community health, rising trends in obesity and overweight, and increasing health disparities. Local health disparities reflect those across the nation. African American men and women in Metro Louisville consume fewer fruits and vegetables, and suffer from many diet-related illnesses more frequently than their white counterparts (Louisville Health Department, 2005).

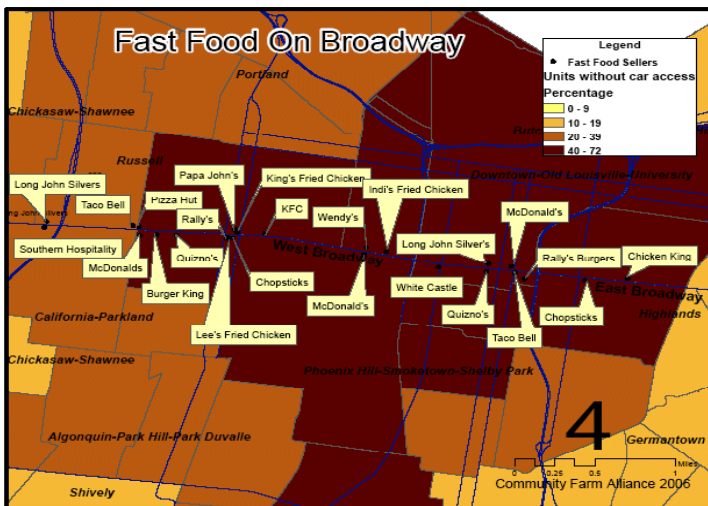

Figure 2. Fast Food on Broadway (CFA, 2007 p. 12). Residents in West Louisville and East Downtown live in an urban environment saturated with fast food restaurants that offer low quality foods at deceptively affordable prices.



As outlined above, food insecurity and poor nutrition have especially detrimental consequences for young people. The YFDP aimed to understand how the food desert conditions in West Louisville and East Downtown neighborhoods could impact the eating habits of local youngsters. The project centered on middle school students because they fall into an important age group in terms of the development of healthy or unhealthy eating habits (Ogden, Flegal, Carroll, & Johnson, 2002). The objective of the YFDP was not to perform a nutritional assessment, but rather to provide a food centered learning opportunity to local youth and to gain an overall sense of what young people in these food desert areas were eating on a day-to-day basis, to discern patterns in their eating habits and preferences, and to gain insight into their perceptions of the meaning of food in their lives. The YFDP food diary assignments were designed to assess these group patterns rather than to quantify or draw conclusions about individual students' intake of specific nutrients. To accomplish this goal, we developed an innovative, educational, and non-invasive method for assessing eating patterns and preferences among student groups.

Methods

The YFDP was approved by the University of Louisville's Institutional Review Board and by Jefferson County Public Schools' Office of Accountability Research and Planning. We recruited teachers based on their interest in using the food diary project materials in their classrooms. The process of connecting with teachers interested in participating in the project was facilitated by the Partnership for a Green City's Environmental Education Committee, with whom the project also became affiliated. Teachers and students at three local schools participated in the project, and presentations, food diaries and writing assignments were adapted into science, social studies, physical education and practical living classes at different middle grade levels during the 2006-2007 school year.

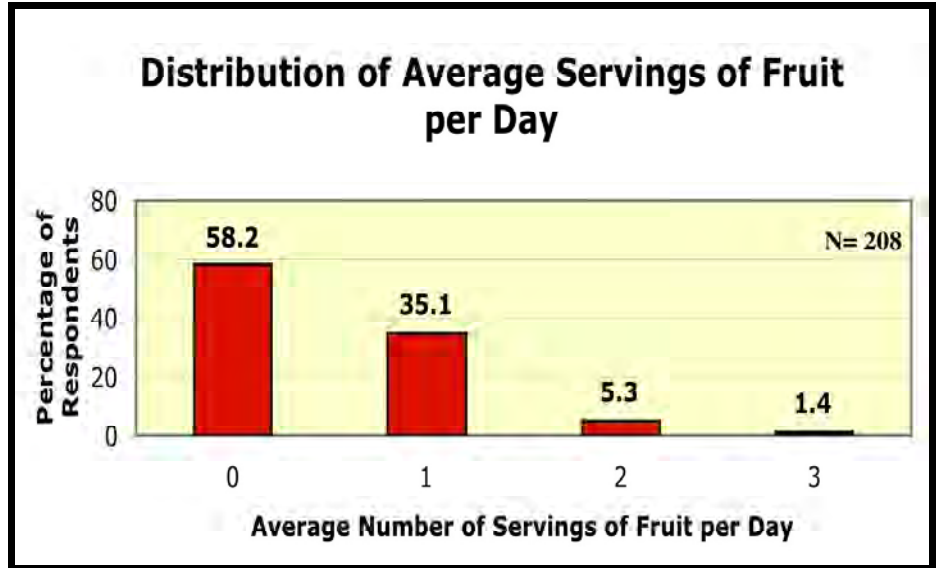

Figure 3. Distribution of Students' Average Number of Fruits per Day. Most students ate one or fewer servings of fruit per day including fruit juices.

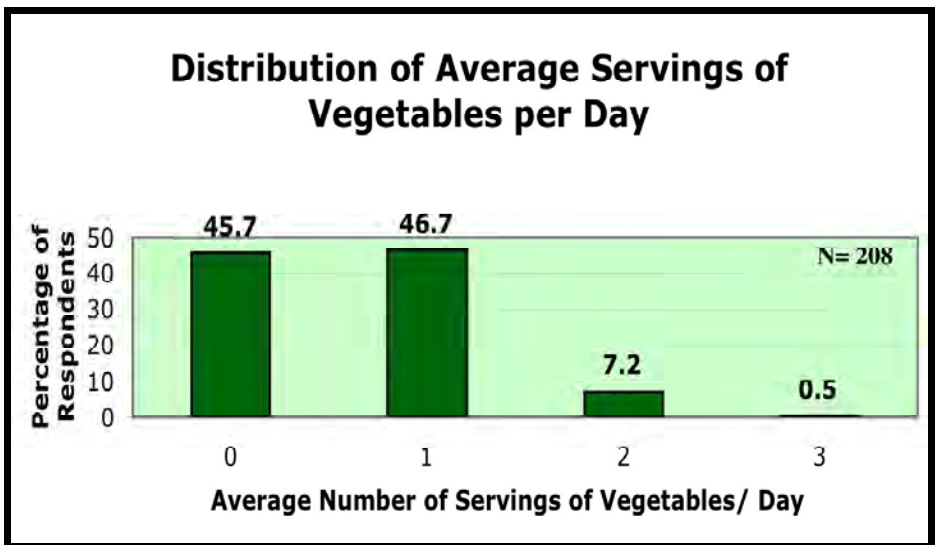

Figure 4. Distribution of Students' Average Number of Vegetables per Day. Most students ate one or fewer vegetables per day even when counting french fries as a vegetable serving.

Nutrition presentations covered nutrition basics such as the food pyramid, how to read nutrition labels and determine serving sizes, and emphasized important qualities of a healthful diet such as fruit and vegetable and whole grain consumption. After hearing these presentations in the classroom, students completed the three-day food diary assignment by recording what they ate, when they ate, with whom they ate, who prepared their food, and where the food they ate was procured for three consecutive days. For each day of the diary, they also indicated

their favorite meal and reasons why they liked it. Students also completed a writing assignment in which they wrote a one-page essay detailing their favorite meals. They were prompted to imagine their favorite meal and to describe what and where they would eat, with whom they would eat and what they would like to do while they ate. They were also asked to explain why the meal they chose was their favorite.



Data Analysis

Anonymous diaries and writing assignments were collected from participating teachers, and entered into SPSS and Excel program files for the analysis of the food diary data. These programs were used to generate descriptive statistics regarding the frequency with which students consumed certain types of foods such as fruits and vegetables and fast food, and frequency with which students ate alone. Pile sorting and Coding were employed in the analysis of the written component of the assignment to facilitate the identification of common themes in students' essays. (Bernard, H.R., 2005).

Results

Teachers and students at three local middle schools completed the project and 208 diaries were collected and analyzed. The most striking diary findings relate to students' fruit and vegetable and fast food consumption habits. Students reported eating a very limited number and variety of fruits and vegetables. The results did not improve as the project unfolded. Out of a sample of 208 diaries, 93 percent of students averaged one or fewer servings of fruit and 92 percent one or fewer servings of vegetables per day (See Figure 3 & Figure 4). Only 13 students reported consuming five servings of fruits and vegetables in any of the three days of the diary and not a single student reported eating five servings of fruits and vegetables per day on all three days of the diary assignment.

The three-day diary assignment spanned across weekend and weekdays in order to reflect what students were eating in home, community and school contexts. Unfortunately, students fared even worse in terms of fruit and vegetable consumption on schooldays. Among those students that did report eating fruits or vegetables, servings commonly came in the form of fruit juice and fried potatoes.

In addition to insufficient fruit and vegetable consumption, the diaries point out alarming patterns in terms of fast food and fried food consumption habits. Sixty percent of students averaged one or more fast food meals per day of the diary, with some students eating fast foods up to three times per day (See Figure 5). The fast food meals students ate included high-calorie, high-fat foods like cheeseburgers, french-fries and pizza.

The food diaries also illuminated that students are consuming many of their foods in solitude each day. Eighty-nine percent of the children averaged at least one meal or snack alone per day (See Figure 6). This is important because it indicates that children are making many of their food choices without parental supervision or guidance, which has been shown to contribute to healthier eating. The rate at which students reported eating alone is especially poignant because students' essays reveal just how much they value food for the social bonds and connections that surround eating. An overwhelming majority of student essays touched on the role of food in connecting them with family and

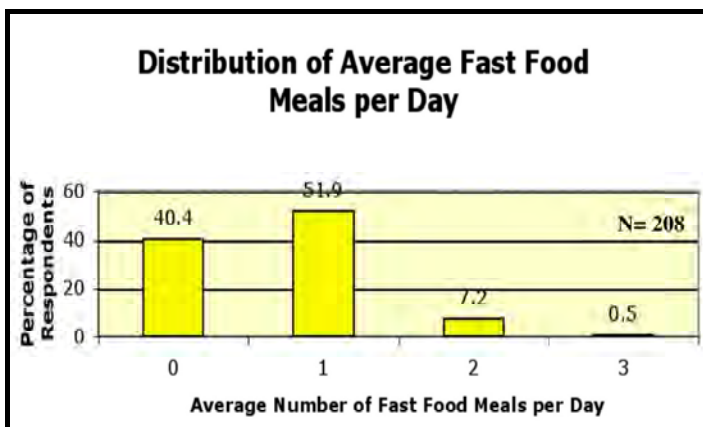

Figure 5. Distribution of Students' Average Number of Fast Food Meals per Day. Most students averaged at least one fast food meal per day and some students ate fast foods up to three times per day.

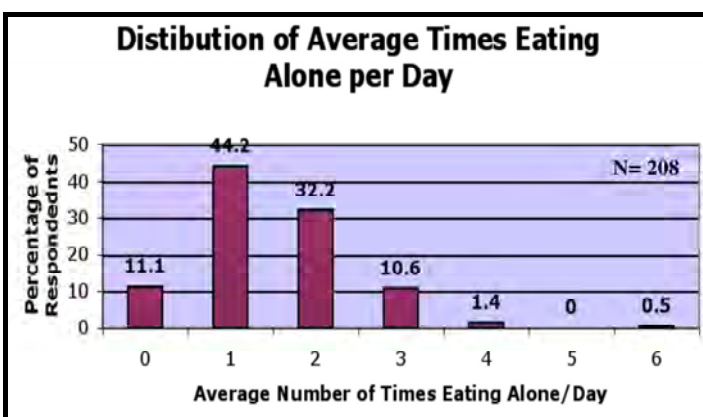

Figure 6. Distribution of Students' Average Number of Meals and Snacks Eaten in Solitude Each Day. Most students ate alone at least once per day.

friends. They wrote about sharing meals with parents and siblings, extended family get-togethers, and food-centered celebrations.

Students enjoyed the essay assignment and had fun with it. Their essays covered a range of eating scenarios, but common themes emerged. Students expressed that they valued food for the connections with family and friends that go hand-in-hand with eating. They wrote about enjoying family conversations at the dinner table and "sharing secrets" with friends while eating. For example, students wrote:

I like eating this food [steak] with my family...we talk about our day and anything really.

I like eating with my brother. We see who can eat the most. I prefer savoring the moment, but beating him is better. I get to beat him and eat my favorite food.

I love to eat cheese soup with my mama because we act funny, joke around, talk about our problems, and how school and work is going.



Another Student described eating with a friend:

I like to eat with my friend because she is so funny...When we eat together we start talking about something and end up with our drinks coming out our noses!

Many student essays expressed that personal choice and taste were highly valued in their food selections. When asked to describe why they liked a certain food each day, students commonly responded, "Because I chose it."

Essays revealed that students commonly enjoyed foods such as pizza, fast foods, french fries, sweet foods and meats, such as steak and chicken. Students wrote:

My favorite food is pizza. I like the gooey cheese and the big red peperonys.

My absolute favorite food is French fries. Not just any fries, McDonalds. They have to be dipped in a McDonalds triple thick shake.

My favorite meal is steak. I love it because it's so juicy, tender and great tasting.

My favorite food is steak because it's so juicy thick and perfect!

Students frequently wrote about enjoying television with meals and eating out, often at fast food restaurants and steakhouses.

My favorite meal would include a bacon burger with fries and a coke with my friend in my living room watching wrestling.

Many students wrote about food preparation and mentioned enjoying helping with meals. Others said they hated or didn't know how to cook. One student wrote:

I like helping my mom and dad cook the chicken. Sometimes I even get to cook the crispy chicken by myself. I like helping cook because it also makes me feel older and like I have more responsibility.

Another student wrote:

I like preparing the steak on the grill because I know how to cook it, but I don't know how to prepare the mashed potatoes or corn.

Some students preferred not to cook:

I don't enjoy preparing food because I think it's too much work.

I don't prepare it I just eat it.

I don't like cooking at all. To me it's really hard.

The diaries indicated that many students are involved in food preparation and often prepare their own meals. Students also associated food with cultural, religious and family identity. For

example, one student wrote about the connection to New Orleans and Jambalaya:

My favorite food is Jumbalaya. I like Jumbalaya because you can put anything in it-- sausage, shrimp, anything. The main reason I like Jumbalaya is because it is a New Orleans food, like me. It really doesn't matter who I'm eating it with. I'm cool as long as I get me my Jumbalaya. I like to eat it in New Orleans because when I eat it there I know the best made it.

Students also conveyed that food was a source of happiness and comfort, and relaxation, peace and quiet. For example:

When I eat chips and salsa, I just feel good; and I guess I feel relaxed.

I like eating by myself..it's very peaceful.

Discussion

The Youth Food Diary Project provided a food and nutrition centered learning opportunity for students that supported teachers' core content material and at generating relevant data for CFA's food assessment. Food records are highly valued as tools for measuring dietary intake and have been used to quantify and characterize eating habits among different groups for a wide variety of research and educational purposes. Food records have proven more accurate than other methods of dietary assessment such as food frequency questionnaires or recall interviews (Ambrosini, Mackerras, de Klerk & Musk 2002; Gersovitz Madden, & Smicikles-Wright, 1978). They have proven especially reliable in comparison to other methods when used with children and adolescents (Crawford, Obazaneck, Morrison & Sarry, 1994; Andersen, Bere, Kolbjornsen, & Klepp, 2004; Rocket and Golditz, 1997). A recent study evaluated the accuracy of self-reporting in food records used with American Indian children and found that participants "were able to accurately recall the majority of foods that they were independently observed consuming during school meals" (Weber et al., 2004, p. 746).

The style and design of food records may vary, but the basic concept of recording food consumption patterns is consistent. Andersen et al. (2004) recommended using a dietary assessment method with young people that could "be filled in by children themselves as part of a school exercise" (p. 771). Our three-day food diary assignment followed this recommendation and also employed visual stimuli in the form of pictures of different types of foods. These images were incorporated into the diary in order to attract and maintain students' attention and interest (Baranowski et al., 1986, p. 1382). The food diary assignment drew on the "estimated record technique" described in Nutritional Anthropology literature (Quandt, 1986; Quandt, 1987). This technique requires subjects keep an ongoing diary of foods they eat for a defined period of time. Nutrition researchers and health education professionals suggest that the food recording process last from between three and seven days (Johnson, 2002, p. 63S). In



the past, longer seven-day records were considered optimal. However, research suggests that reliability of food records can lessen with the length of the recording process (Gersovitz et al., 1978). At least three days is suggested to assess usual dietary patterns as opposed to a 24-hour snapshot that could exhibit out-of-the-ordinary eating habits.

The YFDP used a community-based research model that merged food and nutrition education with the CFA's assessment effort. The success of the collaborative approach to the project indicates that health and nutrition education programming and community-based research can be integrated into classroom activities in a way that is enjoyable for students and that supports teachers' learning objectives. The project aimed to engage student participants in a food-centered learning process that commanded their interest. Food diaries are valued as educational tools and intervention components and are employed in health education and promotion programs throughout the United States. Johnson-Taylor and Everhart (2006) note that food diaries make excellent teaching tools because they increase subjects' awareness of what they are eating (p. 945). Our food diary assignment also incorporated record keeping of other behaviors such as food preparation and shopping habits. The idea behind including these items in the assignment was that enabling children to understand the "whole story of food" could help them improve their eating habits (Earth Friends, 1995).

Children in the United States are increasingly disconnected from the foods they eat. As Harmon and Maretzki (2006) point out, children have a limited understanding about where food comes from, how it is grown or raised, how it is processed and prepared, or how it makes its way to their plates. The food diary assignment required students to consider where and how the foods they ate were purchased and prepared, and illuminated various components on the consumption side of the food system. This approach is supported by research that suggests exploring the food system as a whole and drawing connections between its different components improves children's overall food literacy and can help them improve their eating habits. Furthermore, the writing assignment gave students the opportunity to gain insight into the social role and meaning of food in their families, schools and peer networks. This part of the assignment also supported a reflective writing requirement for JCPS middle school students. In terms of the research objectives, the written portion of the assignment generated qualitative data regarding students' food consumption habits and preferences, as well as the meaning of food in their lives.

Most importantly, the Youth Food Diary Project benefited student participants. First, the

nutrition presentations and diary assignments were educationally valuable. By engaging in the interactive presentation, asking questions and completing the assignments, students had the opportunity to gain insight into their own eating habits and other food-related behaviors. Moreover, they learned by considering the social role and value of food in their families, schools and peer networks. In addition to educational benefits, the data generated by the student diary and writing assignments has research value with potential benefit to children's health. Honing in on the social and environmental factors and food-related health behaviors that contribute to adverse health outcomes in children of this age group is key to prevention. Understanding what children eat and why they make the food choices they make is also essential to developing more effective ways to promote healthy lifestyles among young people. Finally, gaining insight into the social role and meaning of food in children's lives is critical to improving health education and promotion efforts. In this regard, the project highlights areas for further research.

An important strength of the methodology was that participation placed a low burden on participants and offered educational benefits. Students enjoyed the diary assignments and presentations. They asked questions and engaged in the diary process. Teachers also enjoyed the diary project and expanded the assignment to meet their unique classroom goals. For example, one teacher asked students to draw pictures of their favorite meals on paper plates to initiate a classroom discussion (See Figure 7). Other teachers requested more time to use the diaries in their classrooms because, like Johnson and Earhart (2006), they saw the student food diaries as valuable teaching tools.



Figures 7. Students' Favorite Meal Drawings. One teacher added to the diary assignment by asking students to draw their favorite meals on paper plates to initiate a classroom discussion. (Photos by Angelique Perez)



The connection between the YFDP and CFA's wider food assessment, which examined environmental barriers to accessing healthy food, accounts for another of the project's defining strengths. The YFDP sought to empower students to make healthier food choices by providing a fun opportunity for nutrition education and life skill development. The YFDP's place within CFA's assessment also connects the project to a wider process aimed at improving the environment in which youth food choices are made. Often times, nutrition programs focus solely on the function of individual choice in nutrition behavior, and rely solely on educational efforts to improve individual eating habits. While nutrition education is extremely important, educational programs are much more effective when linked to broader health promotion strategies focused on community empowerment and improving the context in which individual food choices are made and constrained (Tuttle, Derrick, & Tagtow, 2003). The YFDP was unique because the results were incorporated into CFA's collaborative assessment, which is already being used to advocate for food and economic justice in West Louisville and East Downtown.

The food diaries served as an excellent method of assessing patterns in students' eating habits. The results reveal that a vast majority of student respondents from these West Louisville and East Downtown middle schools are not reaching recommended levels in terms of the amounts or the variety of fruits and vegetables they are eating each day. Student respondents reported eating far less than 2-3 cups of vegetables and 1.5-2 cups of fruit recommended by the USDA's My Pyramid dietary guidelines for children in this age group depending on gender, and physical activity level. Unfortunately, students are faring even worse in terms of fruit and vegetable consumption on school days. Those students that are eating fruits and vegetables are commonly getting them in the form of fruit juice and fried potatoes at home and at school, which is certainly not the optimal scenario. Other studies confirm fried potatoes as a food favorite among young people and suggest

this preference is all too commonly reflected in school cafeterias. This reflection has been deemed likely to reinforce preferences for high-fat and fast foods (Kubik, Lytle, Hannan, Perry, & Story, 2003, p.1172). Brantley, Hunt, Gerald, & Ryan (2005) also revealed that frequent exposure and consumption of high fat food items reinforces taste preferences for these foods.

While reporting insufficient fruit and vegetable consumption, a majority of students reported eating high-calorie, high-fat fast foods at least once per day. This pattern has serious health implications for local youth. YFDP student participants reported eating fast food meals at a rate that far exceeds rates from a national survey, which showed 30 percent of American youths between ages four and seventeen consume fast food on a typical day (Bowman, Gortmaker, Ebbeling, Pereira, & Ludwig, 2004). The same household survey indicated that children who ate fast foods averaged a higher consumption of total energy, total fat, total carbohydrates, added sugars, and sugar-sweetened beverages than those students that did not. Demonry-Luce (2005) reviews ways in which frequent fast food consumption erodes children's dietary quality. She emphasizes that children who frequently consume fast food are more likely to have higher energy and fat intakes. These children are also likely to eat more "energy dense soft drinks, cheese-burgers and french fries" and to eat less "nutrient dense fruits and vegetables and milk" (p. 280-281). All of these dietary consequences are associated with negative health outcomes in young people. These unhealthy foods are advertised to children relentlessly. Story et al. (2002) note that fast food restaurants alone spend \$3billion annually on advertising (p. S48). These authors estimate if the average adolescent views about 2.5 hours of television per day, they are also exposed to about 105 minutes of commercial advertising each week (p. S48).

Students also reported eating in solitude on a regular basis. This pattern is alarming because evidence clearly demonstrates that children's participation

in family meals can contribute to healthier eating. One study found that frequency of family meals was positively associated with intake of fruits, vegetables, grains and calcium rich foods, and negatively associated with soft drink consumption among young people (Neumark-Sztainer, Hannan, Story et al., 2000). Another found that adolescent girls who reported "more frequent family meals, high priority for family meals, a positive atmosphere at family meals, and a more structured family meal environment were less likely to engage in disordered eating" (Neumark-Sztainer, Wall, Story, & Fulkerson, 2004). These authors emphasize the important role of family meals in promoting positive dietary intake among adolescents, and suggest that feasible ways to increase the frequency of family meals should be explored with adolescents and their families. The diary findings indicate that interventions to increase family meals may find success among young people, as students commonly expressed they valued and looked forward to family meals and food centered get-togethers and celebrations. Story et al. (2002) also see the potential for promoting family meals. They note, "79% of adolescents cited eating dinner at home as one of their top-rated activities that they like to do with their parents" in a national survey (p. S44).

Many students described their involvement (or lack thereof) in shopping and preparing food in their homes. Larson, Story, Eisenberg, & Neumark-Sztainer (2006) contend that there are benefits associated with youths being involved in food preparation. The authors demonstrated that being involved in food preparation was associated with higher intakes of fruits and vegetables among male and female adolescents and lower intakes of carbonated beverages among female adolescents (p. 211).

Finally, the YFDP writing assignment analysis revealed that food is important to middle school-aged children. They value the social connections that surround it, taste and choice and relate food to many facets of their identity. Story et al. (2002) suggest, "Food is inextricably intertwined



with issues of identity, self-concept, friendship, security, independence and authority” (p. S42). These authors reinforce the importance of understanding the “symbolic and functional meanings adolescents attach to food” (p. S42). Developing an awareness of how children relate to food and eating offers a point of connection with them. It is essential to be attentive to children’s food-related values and insights in order to promote healthier diets among today’s youth.

Conclusions

Combined, the individual patterns revealed by the YFDP paint quite a disturbing profile of the eating habits and potential health outcomes of middle school aged children in Louisville. The health impacts associated with these patterns are well documented. Children’s food environments shape and influence their eating habits. Young people are only assured access to healthy food choices when nutritious options are provided in home, community and school contexts. The findings of the YFDP indicate the need for a local food environment that supports better eating habits and health among all local youth.

One of the key predictors of fruit and vegetable consumption among youngsters is availability and accessibility of these foods (Blanchette and Brug, 2005, p. 439). Accessibility can even surpass personal taste as a predictor of fruit and vegetable consumption among children. Recent studies demonstrate that even when taste preferences for fruits and vegetables are low, increasing availability of these foods can also increase intake (Neumark-Sztainer, Wall, Perry, & Story, 2003; Wardle, Herrera, Cooke, & Gibson, 2003). Unfortunately, ready access to affordable healthy foods in the “food deserts” of the West Louisville and East Downtown areas is undermined by a scarcity of retailers that stock affordable healthy foods, by a lack of vehicle access and other affordable and safe forms of transportation, and by an overabundance of convenience stores and fast food retailers that offer an array of unhealthy options.

Promoting healthier diets among Louisville youth depends on eliminating food insecurity, especially in low-income inner-city neighborhoods. This requires policy changes and concentrated efforts to create an economically vital urban environment in which it is easier for children and adults to access fresh, affordable, nutritious foods. CFA’s assessment report (2007) contains specific policy recommendations that could improve food access and health among Louisville’s urban residents. Since its release, the assessment report has been used to promote food access and economic development in West Louisville and East Downtown. The food assessment findings have been presented to local public health officials and city leaders as part of an effort to change policies that hinder urban food access and economic development in these inner-city neighborhoods. The findings are also being shared with community leaders and residents in order to promote civic engagement and political participation in the democratic decision-making processes that shape and influence people’s food access and everyday lives.

CFA has also spearheaded an array of initiatives aimed at creating a more food secure environment in West Louisville and East Downtown. They partnered with the Louisville Metro Department of Public Health and Wellness’ Center for Health Equity to organize a local Food Security Task Force that draws partners from around the city to respond to food security issues. CFA is also fostering the development of food-related businesses, farmers markets and community gardens in West Louisville and East Downtown neighborhoods.

Multifaceted, interdisciplinary approaches aimed at improving food access and eating patterns among children and adults can contribute the most to improving health and quality of life. Story et al. (2002) point to schools as important intervention targets. The authors suggest, “Interventions and policies are urgently needed to control the proliferation of high-fat, high-sugar foods, and soft-drinks in schools and to create a supportive nutrition environment that provides adolescents with the skills and opportunities they need to adopt healthful eating behaviors” (p. S49). The farm alliance is currently collaborating with the Partnership for a Green City, a partnership between JCPS, Louisville Metro Government and The University of Louisville, and Grasshoppers Inc, a farmer-owned local food distribution business, to initiate discussions about how more fresh foods can be channeled into JCPS cafeterias and onto University campuses. These innovative partnerships and efforts to connect low-income, urban residents with nutritious foods are crucial to enhancing food security and improving health in all parts of Metro Louisville.

The author wishes to thank Professor David J. Tollerud, MD, MPH and Lisa B. Markowitz, PhD for their assistance and guidance in conducting this research.

References

- Alaimo K., Olson C.M., Frongillo, E.A., & Briefel R.R. (2001). Food insufficiency, family income, and health in U.S. preschool and school-aged children. *American Journal of Public Health*, 91, 781-786.
- Alaimo K., Olson C., & Frongillio E. (2001). Food insufficiency and American school-aged children’s cognitive, academic, and psychosocial development. *Pediatrics*, 108, 44-53.
- Alter, D.A. & Eny, K. (2005). The relationship between the supply of fast food chains and cardiovascular outcomes. *Canadian Journal of Public Health*, 96(3), 173-177.
- Andersen, L.F., Bere, E., Kolbjornsen, N., & Klepp, K-I. (2004). Validity and reproducibility of self-reported intake of fruit and vegetable among 6th graders. *European Journal of Clinical Nutrition*, 58, 771-777.



- Ambrosini, G.L., Mackerras, D., de Klerk, N.H., & Musk, A.W. (2002). Comparison of an Australian food frequency questionnaire with diet records: implications for nutrition surveillance. *Public Health Nutrition*, 6(4), 415-422.
- Baranowski, T., Dworkin, R., Henske, J.C., Clearman, D.R., Dunn, J.K., Nader, P.R. et al. (1986). The accuracy of children's self-reports of diet: family health project. *Journal of the American Dietetic Association*, 86(10), 1381-1385.
- Bernard, H.R. (2005) *Research methods in anthropology: quantitative and qualitative approaches- 4th edition*. Oxford: Alta Mira.
- Blanchette, L. & Brug, J. (2005). Determinants of fruits and vegetable consumption among 6-12-year-old children and effective interventions to increase consumption. *Journal of Human Nutrition and Dietetics*, 18, 431-443.
- Bowman, S.A., Gortmaker, S.L., Ebbeling, G.B., Pereira, M.A., & Ludwig, D.S. (2004). Effects of fast-food consumption on energy intake and diet quality among children in a national household survey. *Pediatrics*, 113 (1 Pt 1), 112-118.
- Brantly, C.A., Hunt, A.E., Gerald, B., & Ryan, C. (2005). Consumption of high fat foods influences taste preferences. *Journal of nutrition in recipe and menu development*, 3(3/4), 9-17.
- Brown, L. and Pollit E. (1996). Malnutrition, poverty and intellectual development. *Scientific American*, 274, 38-43.
- Centers for Disease Control. (2004). Youth Risk Behavior Surveillance-United States- 2003. *MMRW Surveillance Summary*. 53(2): 1-96. <http://www.cdc.gov/mmwr/preview/mmwrhtml/ss5302a1.htm>
- Community Farm Alliance. (2007). *Bridging the divide: growing self sufficiency in our food supply: community food assessment: a regional approach for food systems in Louisville, Kentucky*. Louisville: Community Farm Alliance.
- Crawford, P.B., Obarzanek, E., Morrison, J., & Sabry, Z.I. (1994). Comparative advantage of 3-day food records over 24-hour recall and 5-day food frequencies validated by observation of 9- and 10-year old girls. *Journal of the American Dietetic Association* 94(6), 626-630.
- Crawford, P.B., Wang, M.C., Krathwohl, S. & Ritchie L. (2006). Disparities in obesity: prevalence, causes and solutions. *Journal of Hunger and Environmental Nutrition*, 1(1), 27-48.
- Denory-Luce, D. (2005). Fast food and children and adolescents: implications for practitioners. *Clinical Pediatrics*, 44, 279-288.
- Earth Friends. 1995. *The Whole Story of Food*. Nutrition Education Resources Project. New York City: Teachers College, Columbia University.
- Eisenhauer E. (2001). In poor health: supermarket redlining and urban nutrition. *GeoJournal* 53, 125-133.
- Gersovitz, M., Madden, J., & Smiciklas-Wright, H. (1978). Validities of the 24-hour dietary recall and seven-day record for group comparisons. *Journal of the American Dietetic Association*, 73, 48-55.
- Harmon, A.H. & Maretzki, A.N. (2006). Assessing food system attitudes among youth: development and evaluation of attitude measures. *J Nutr Educ Behav*, 38(2), 91-5.
- Institute of Medicine -Committee For the Study of the Future of Public Health Division of Health Care Services. (1988). *The Future of Public Health*. Washington D.C: National Academy Press.
- Johnson, R.K. (2002). Dietary intake: how do we measure what people are really eating? *Obesity Research*, 10 (Suppl 1), 63S-68S.
- Johnson-Taylor, W.L., & Everhart, J.E. (2006). Modifiable environmental and behavioral determinants of overweight among children and adolescents: report of a workshop. *Obesity*, 14(6), 929-966.
- Kimm, S.Y., Gergen P.J., Malloy, M., Dresser, C., & Carroll, M. (1990). Dietary patterns of U.S. children: implications for disease prevention. *Preventive Medicine*, 19, 432-442.
- Kubik, M.Y., Lytle, L.A., Hannan, P.J., Perry, C.L., & Story, M. The association of the school food environment with dietary behaviors of young adolescents. *American Journal of Public Health*, 93(7), 1168-1173.
- Larson, N., Perry, C., Story, M., & Neumark-Sztainer, D. (2006). Food preparation and purchasing roles among adolescents: associations with sociodemographic characteristics and diet quality. *Journal of the American Dietetic Association*, 106, 211-218.
- Louisville Metro Health Department. (2005). *Health Status Assessment Report*.
- Louisville Metro Health Department Office of Policy Planning and Evaluation.
- Morland, K., Wing, S., Roux, A., & Poole. (2001). Neighborhood characteristics associated with the location of food stores and food service places. *American Journal of Preventative Medicine*, 22(1), 23-29.
- Morland K, Wing S, Roux A. (2002). The contextual effect of the local food environment on residents' diets: the atherosclerosis risk in communities study. *American Journal of Public Health*, 92(11), 1761-1767.
- Neumark-Sztainer, D., Hannan, P.J., Story, M., Croll, J., & Perry, C. (2000). Family meal patterns: associations with sociodemographic characteristics improved dietary intake among adolescents. *Journal of the American Dietetic Association*, 103(3), 317-322.



- Neumark-Sztainer, D., Wall, M., Perry, C., & Story, M. (2003). Correlates of fruit and vegetable intake among adolescents: findings from project EAT. *Preventive Medicine, 7*(3), 198-208.
- Neumark-Sztainer, D., Wall, M., Story, M., & Fulkerson, J.A. (2004). Are family meal patterns associated with disordered eating behaviors among adolescents? *Journal of Adolescent Health, 35*(5), 350-59.
- Ogden, C.L., Flegal, K.M., Carroll, M.D., & Johnson, C.L. (2002). Prevalence and trends in overweight among U.S. children and adolescents, 1999-2000. *JAMA 288*, 728-1732.
- Quandt, S.A. (1986). Nutritional anthropology: the individual focus. In S.A. Quandt & C. Ritenbaugh (Eds). *Training manual in nutritional anthropology*. Washington D.C.: American Anthropological Association.
- Quandt, S.A. (1987). Methods for determining dietary intake. In Francis E. Johnston (Ed). *Nutritional anthropology*. New York: Alan R. Liss Inc.
- Reisig V. and Hobbiss A. (2000). Food deserts and how to tackle them: a study of one city's approach. *Health Education Journal, 59*, 137-149.
- Rockett, R.H. & Colditz, G.A. (1997). Assessing diets of children and adolescents. *American Journal of Clinical Nutrition, 65*(suppl), 1116S-1122S.
- Schwimmer, J.B., Burwinkle, T.M., & Varni, J.W. (2003). Health-related quality of life of severely obese children and adolescents. *Journal of the American Medical Association 289*:1813-1819.
- Shaw, H.J. (2006). Food Deserts: Towards the Development of a Classification. *Geogr. Ann., 88B* (2): 231-247.
- Story, M., Neumark-Sztainer, D., & French, S. (2002) Individual influences on adolescent eating behaviors. *Supplement to the Journal of the American Dietetic Association, 102*(3), S40-S51.
- Tuttle, C.R., Derrick, B., & Tagtow, A. (2003) A new vision for health promotion and nutrition education. *American Journal of Health Promotion, 18*(2), 186-191.
- USDA- Food and Nutrition Service. (2000). *Measuring Food Security in the United States: Guide to Measuring Household Food Security*. Accessed from <http://www.fns.usda.gov/fsec/FILES/FSGuide.pdf>
- USDA- Economic Research Service (2004). *National Food Insecurity Profile: Household Food Security in the United States*. Accessed from <http://www.ers.usda.gov/publications/err11/>
- U.S. Department of Health and Human Services- Office of Disease Prevention and Health Promotion. (2000). *Healthy People 2010- Volume II (Second Edition: Objectives for Improving Health (Part B: Focus Areas 15-28)*. Accessed from <http://www.healthypeople.gov/Document/tableofcontents.htm#Volume2>
- Wardle, J., Hererra, M.L., Cooke, L., & Gibson, E.L. (2003). Modifying children's food preferences: the effects of exposure and reward on acceptance of an unfamiliar vegetable. *Journal of Health Education, 29*, 26-32.
- Weber, J.L., Lytle, L., Gittlesohn, J., et al. (2004). Validity of self-reported dietary intake at school meals by American Indian children: the pathways study. *Journal of the American Dietetic Association, 104*(5), 746-752.



Photovoltaic Street Lights in Louisville, Kentucky

Maria Dawson

**Advisor: Dr. Keith Sharp
University of Louisville
Speed School of Engineering**

Abstract

The objective of this project was to determine the feasibility of solar-powered streetlights in an urban environment. The application of solar-powered streetlights in urban environments can be challenging due to potential interference, such as shadowing from neighboring buildings. However, the potential cost savings in an urban environment are considerable due to the number of streetlights normally present there.

Three solar-powered streetlights from different manufacturers were tested. The objectives for the project include the comparison of the light intensities and the durations of the light output for the three streetlights. The light output was analyzed during different times of the year and through different weather conditions.

This project included a comparison of the solar-powered streetlights to the control light. Also, benchmarking was completed to determine what light intensity ordinary streetlights should maintain.

Light intensities, efficiencies, and solar radiation were compared over the entire duration of this project, which was approximately three months. Results were compared both to the control light and between the three solar-powered lights. The comparison of the different manufacturers' lights also included information about the types of solar cells, batteries, and light bulbs that were used.

Background

Solar-powered streetlights are beneficial for several reasons. Since they do not need AC power, there are no utility costs. The pollution caused by a PV light is also virtually zero. A traditional light, on the other hand, is energized by utility power, which is typically created by the burning of fossil fuels, which releases significant pollution into the environment. In addition, the availability of fossil fuels in the future is uncertain, making it important to investigate the viability of alternative energy sources if we are to continue using energy at such a rapid rate.

Peak oil production is expected to occur within the next 20 years. An exact figure is difficult to pinpoint, but several sources have published estimates. A U.S. Department of Energy study conducted in 2000 analyzed 12 different scenarios for peak oil production. The mean year of peak oil production from these scenarios was 2016 (Dillin 2005). M. King Hubbert developed a formula in the 1950's to predict peak oil production. This formula predicted U.S. oil production would peak in the 1970's, which proved accurate. Using the same formula for world oil production, peak production should be approximately 2030 (Davy 2005). Other independent experts expect oil production to peak

Projected Date	<i>Source of Projection</i>	<i>Background & Reference</i>
2006-2007	Bakhitari, A. M. S. Simmons, M. R.	Iranian oil executive investment banker
After 2007	Skrebowski, C.	Petroleum journal editor
Before 2009	Deffeyes, K. S.	Oil company geologist (ret.)
Before 2010	Goodstein, D.	Vice Provost, Cai Tech
Around 2010	Campbell, C. J. World Energy Council	Oii company geologist (ret.) Nongovernmental org.
After 2010	Laherrere, J.	Oil company geologist (ret.)
2016	EIA nominal case	DOE analysis/information
After 2020	CERA	Energy consultants
2025 or later	Shell	Major oil company
No visible peak	Lynch, M. C.	Energy economist

Table 1. Projections of the world's peak oil production.



prior to 2015 (Black 2005). A comparison of various experts' opinions of when peak oil production will occur is shown in Table 1 (Hirsch 2005). Most experts agree the oil production peak will occur between 2007 and 2025 (Hirsch 2005).

In addition to oil production peaking, world use is rapidly increasing as well. In 2004 in China alone, oil consumption increased 16% (Guntermann 2006). As a matter of fact, in 2004, China was the second largest consumer of oil in the world (Kunstler 2005).

It is estimated that 25% of the United States' annual electricity production is used to provide lighting. In fact, the amount of electricity used for lighting is equal to the output of approximately 100 large power plants. The pollution caused by this electricity production equates to 450 million tons of carbon dioxide and three million tons of nitrous oxide and sulfur dioxide (Raloff 2006). The development of solar-powered lighting has the potential to significantly reduce the amount of electricity the United States needs for lighting.

Another potential benefit of solar-powered lights is the cost savings related to the installation of power to a traditional streetlight. At times, providing utility power to standard lights can be difficult, especially if trenching concrete is involved. Additionally, solar-powered lights can be useful in applications where utility power is not convenient or available.

Solar-powered, or photovoltaic (PV), technology has been in development since the 1950's (Miles 2006). However, it has been regarded as a viable energy source only for about the last 30 years. It is virtually pollutant-free, and is available in abundance. In addition, the costs for the technology have decreased dramatically in the last 30 years, further promoting its viability. The maintenance costs are also significantly lower than that of traditional power sources.

One fairly recent application for this technology is solar-powered streetlights. Solar-powered streetlights provide light without the need for AC utility power. Sunlight is converted into energy through the use of a photovoltaic cell. This cell converts solar energy into electrical current, which can be immediately used or can be stored via a battery pack to be used at a later time. The amount of energy available can be increased simply through the addition of solar cell panels. This provides flexibility for a variety of applications.

Traffic.com currently uses over 3000 solar-powered traffic sensors to monitor traffic flow. Solar power was attractive for this application because providing utility power in many locations would have proven difficult and expensive. Photovoltaic cells have been found to be a dependable power source for this use (Costlow 2005).

A solar, or photovoltaic, cell uses semi-conductor material to convert sunlight into electric current (Kammen 2006). The angle of tilt for the panel can greatly affect the amount of energy it produces, as can the location (Roman 2005). A solar cell is general-

ly composed of two layers of a semi-conductor material, usually silicon. The two layers intentionally contain different chemical impurities, which produce different charges on the two layers. These opposing charges allow the cell to produce electricity when electrons are freed from the semi-conductor material by sunlight.

Three main types of cells are currently available: crystalline, III-V, and amorphous. All but the III-V types of cells use a silicon semi-conductor material. Crystalline is broken down into two types, monocrystalline and polycrystalline (Livingston 2006). Monocrystalline means the silicon is obtained by sawing thin plates from a silicon crystal rod. This type of solar cell is fairly efficient. Polycrystalline cell production involves pouring liquid silicon into blocks, which are then sawed into plates. This method is generally more cost-effective, but the efficiency of solar cells produced by this method is less because the method allows defects to form in the silicon blocks. III-V solar cells use gallium arsenide or indium phosphate instead of silicon (Miles 2006). Due to the increase in solar cell production over the last decade, a shortage of highly purified silicon has occurred. This silicon shortage makes the prospect of III-V cells appealing. Advantages also include a higher efficiency (~37%), but they typically have a much higher production cost (Carts-Powell 2006).

Amorphous solar cells are produced by placing a thin silicon film on a plate of material, usually glass. However, an amorphous laminate can also be bonded to other materials, such as a metal roof. Less material is used in producing amorphous cells, as the film is very thin, so the production costs are usually the lowest. In fact, this type of cell uses about 100 times less silicon than crystalline cells (Long 2006). However, the efficiency of amorphous cells is also the lowest, meaning it requires a greater surface area to generate the same wattage (Livingston 2006). As a matter of fact, crystalline cells generally have a 15-30% greater efficiency than amorphous cells (Kammen 2006). Therefore, amorphous cells are not typically used in solar-powered streetlights. Instead, polycrystalline solar cells are used because they provide the best efficiency.

A fourth type of photovoltaic technology is in development. It uses cadmium selenide quantum dots on titanium dioxide films to convert sunlight to power. The potential for this type of cell is great because, theoretically, a single photon could be able to excite two electrons, allowing high efficiencies. However, this technology has yet to be perfected, so it is not used in commercial applications (Overton 2006).

Overall, photovoltaic cells create energy at a cost of approximately 28 cents per kilowatt-hour, and are about 8-15% efficient (Guntermann 2006). Polycrystalline cells are at the high end of this range, at about 15% (Kammen 2006). The annual production of PV cells has increased approximately 25% per year for the last 10 years. In 2005 alone the production of these cells increased 45% (Kammen 2006). The average direct manufacturing costs decreased 56% between 1992 and 2002 (Mooney 2003), which likely has helped promote PV cell technology as an alternative to fossil fuels.



Various types of light bulbs can be used in conjunction with solar cells. These include light emitting diodes (LED), high intensity gas discharge (HID), including low-pressure sodium (SOX), and compact fluorescent (CFL) bulbs.

Procedure

In this study, it was hypothesized that solar-powered streetlights would provide lighting comparable to that of standard streetlights. The performance of the different manufacturer's lights were compared to one another. Another objective of this study was to determine what, if anything should be modified to improve the feasibility of solar-powered streetlights.

Three solar-powered streetlights were installed in downtown Louisville at 6th and Market Streets on July 25, 2006. Data collection boxes (Hobo Pendant Temperature/Light Data loggers), were installed on the same light poles to measure both the light output and the outside temperature. A data collection box was also installed on a standard streetlight pole in the same area. The data from this pole was used as a control for the experiment. Data readings were recorded every five minutes via the collection boxes. The PV panels were oriented at 45 degrees to horizontal.

These streetlights were purchased as kits from three different manufacturers: SOL, Sepco, and SC Solar. They were installed on Market Street, adjacent to one another. They were also adjacent to the standard streetlight. A table comparing the various components is shown in Table 2. Photographs of the light pole installations are shown in Figures 1-2.

Light intensity data was collected from the data loggers by connecting a laptop computer to the output, and downloading the information. Specific software, Hoboware version 2.2.0, was used for the collection. It has the ability to both plot the data

	SC Solar	SEPCO	SOL
	X-35	SLR-18 (SELS160)	PM Series
Lamp	High intensity gas discharge	Compact fluorescent, 32W	Compact fluorescent, 32W
Lumens	3600	1200-3200, 1800	1620
Beam Width at .5FC	100 X 30'	120 X 60	
Minimum and Max Temp	-35/85 C	-15 F	-30 F
Panel Manufacturer	Sharp or TSR	Shell Solar	BP Solar
Peak power of Panel	170 Watts	225 Watts	250 Watts
Controller	Morningstar	SEPCO	SOL
Warranty			
- panel	25 year	25 years	25 years
- battery	1 year	3 years	Pro-rated
- controller	2 years	5 years	
- system		2 years	5 years
Battery	Gel, 180 amps	Gel, 224 amps	Gel, 200 amps
Battery life	5 years	5 years	5 years
Certification	In process of being certified	Florida Solar Energy Center, IUS	Florida Energy Center, GSA
Other	Uses micro-electronics in lieu of photocell, 2 panels and 2 batteries	Solar panel installed separately from light. Low pressure sodium 1600 hour, fluorescent 1200 hrs. Battery is on support arm.	Can install up to 3 solar collectors. Lamps will last 5 years

Table 2. Solar Streetlight Component Comparison

within its software, and to output the data to a Microsoft Excel file. The batteries in the data collection boxes were replaced in late October, and generally last several months.

The data collection boxes recorded the light intensity and ambient temperature every five minutes. The frequency is adjustable, but five minutes was sufficient to provide an accurate reflection of the light output from the solar-powered lights. The output from the streetlights was exported to Microsoft Excel. The data was then analyzed to determine whether the output light intensity from the solar-powered lights was comparable to that of the standard streetlight. If so, then a secondary goal was to determine which manufacturer's product was superior in terms of output intensity and duration.

Results

The first set of data was collected on September 7, 2006, and the second set was collected on October 31, 2006.

The output from the solar-powered lights was compared during the nighttime hours. The daylight exposure was also compared. An understanding of how much light the solar



Figure 1. A solar-powered streetlight.



Figure 2. Another type of solar-powered streetlight.



panels were receiving during the daylight hours was important in understanding the outputs at night. The analysis was required to show whether the streetlights were providing output all night, as well as what their intensities were throughout the night.

The analysis had to include many days of data without being overloaded by a large number of data points. In order to accomplish this, the average intensity provided by each light each night was compared. The daytime exposures were also averaged for each day for each light. The points were plotted on two separate graphs, one for day and one for night. The graphs were then used to determine which lights were providing adequate output, as well as to note any correlations between light exposure during the day and intensity at night.

The duration of light from each source was also plotted for each nighttime period. This information allows us to see which light kits are able to store enough energy throughout the day to provide sufficient output throughout the night. To further investigate the durations, plots were also completed to compare nighttime duration to daytime exposure for each of the three solar-powered streetlights.

According to the Illuminating Engineering Society of North America (IESNA), the recommended lighting level range for roadways in commercial areas is 0.2-1.2 footcandles, measured horizontally at ground level (publications IES RP-8-83 "Roadway Lighting"). The levels provided by all four streetlights were benchmarked against this standard.

The data recorded during this project was directly beneath the streetlight head, at a distance of approximately 20 feet to the ground. Since the industry standard for illumination levels on roadways is given at street level, the light intensity at ground level was calculated.

The efficiencies of the solar-powered streetlight systems were calculated by dividing the integrals of the intensities over time during the night hours by the integrals of the intensities over time during the day hours.

Error could have been introduced into the data by light in the surrounding area. Since the lights were installed downtown, there were multiple other light sources during the night, including a nearby parking garage and lights on adjacent buildings. These other sources could have caused some artificial inflation of the light intensities recorded by the data loggers. The output from the lights without interference could be recorded by moving the lights to a remote location. Light intensity readings could then be measured, and this data could be used to normalize the data recorded during our experiments. However, due to time constraints, this measurement did not take place prior to the completion of this research.

The plot of the average light intensities during the night is shown in Figure 3. The dates of the data are July 27, 2006 through October 31, 2006. The control light has the greatest output of all the lights in the experiment. At a close second is the light manufactured by SC Solar. The SOL light is next in intensity level. Finally, the light manufactured by Sepco is last in output, with an average intensity well below that of the control light and the other two solar-powered lights.

The plot of the average day intensity is shown in Figure 4. At times, the SOL light experienced better daytime exposure than the other lights. A discrepancy in the amount of daytime exposure between the various lights can be noted.

The duration of nighttime illumination for the streetlights is shown in Figure 5. The nights when the light output from both the SC Solar and the SOL lights was not sufficient throughout the night can be noted from this plot. These plots were obtained by calculating how many hours each light lasted each night during the data collection period. The starting time was when the lights came on, and the end time was when the light intensity went to zero or when the sunrise occurred. This is further shown in the plot of the durations of light versus the daytime exposure for each of the streetlights, shown in Figure 6-8. The SOL light failed to last all night when there were consecutive days of poor daytime

intensity levels. This was the case on several occasions. The manufacturer was contacted in case these failures were due to an electrical problem, such as bad batteries or controls. Investigation into these possibilities was ongoing at the completion of this project.

The efficiencies of the solar-powered streetlight systems were calculated. The results are shown in Table 3. The SC Solar streetlight system was calculated to be the best, followed by the SOL system then the Sepco system.

The average ground level illumination for the standard streetlight was 0.55 footcandles. The average ground level illumination was also calculated for the three

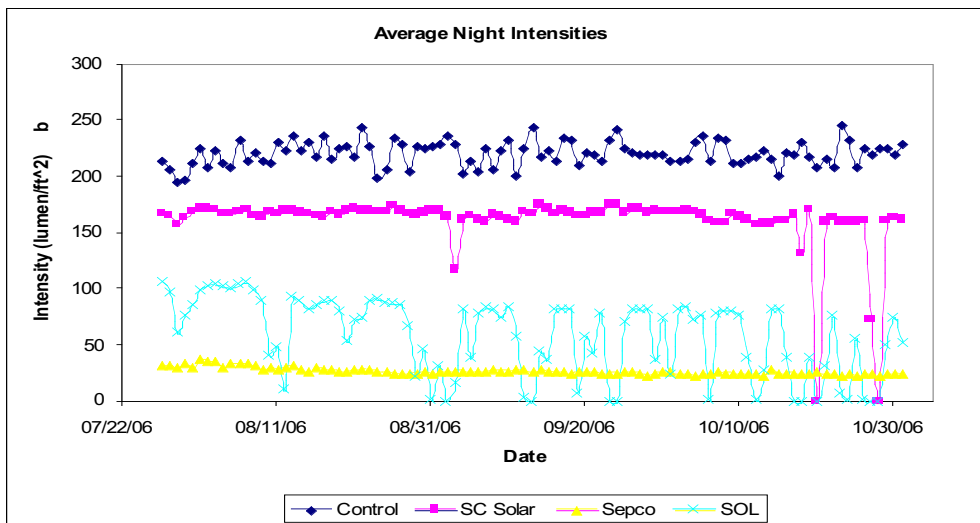

Figure 3. Average night intensity from 7/27-10/31.

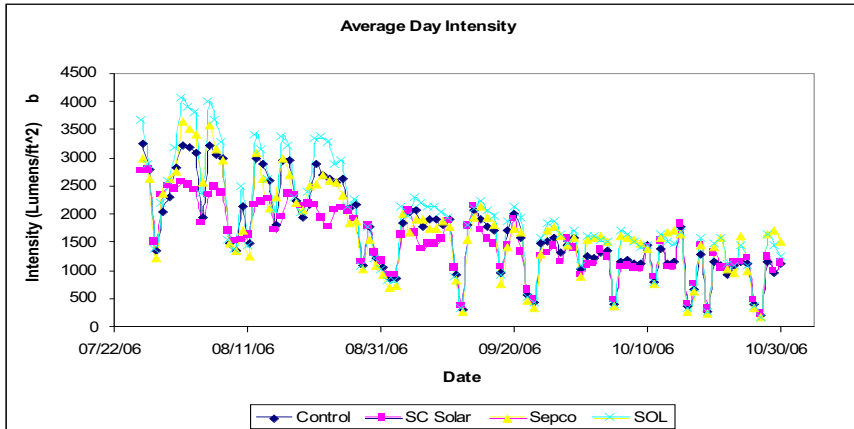

Figure 4. Average day intensity from 7/26-10/31.

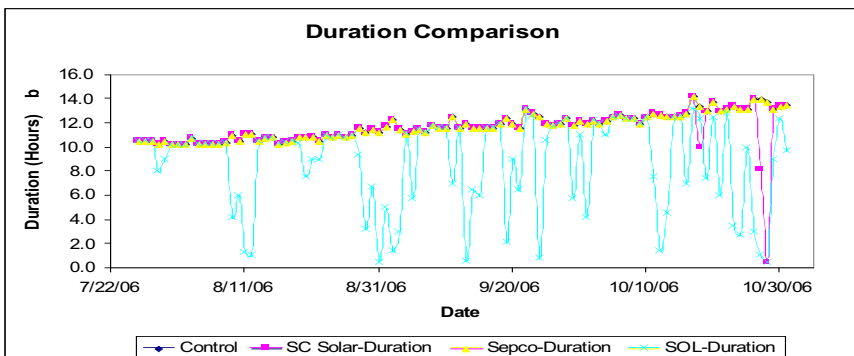

Figure 5. Duration comparison from 7/26-10/31.

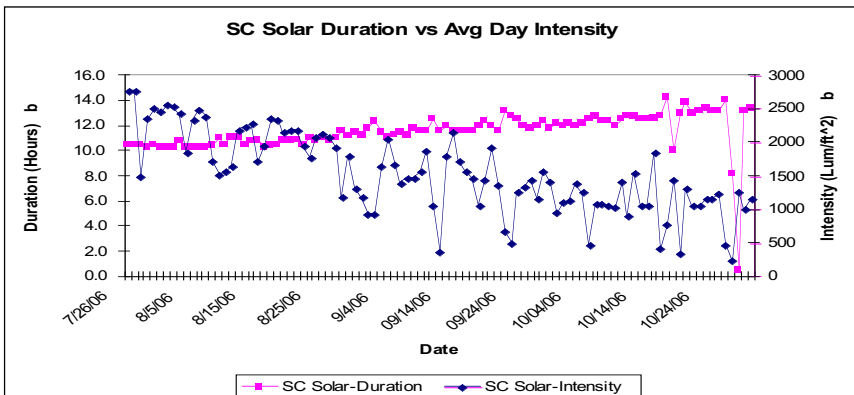

Figure 6. Durations and Average Day intensity for the SC Solar light.

Manufacturer	SC Solar	Sepco	SOL
# Nights light failed to last all night	4/89	0/89	49/89
% effective (duration)	95.5%	100.0%	44.9%
Efficiency	9.82%	2.90%	1.40%
Average ground level illumination	0.41 fc	0.06 fc	0.21 fc

Table 3. Summary of the solar-powered streetlights' performance.

solar-powered streetlights. The calculation only took into consideration the hours when the streetlight actually provided output. The results of the ground-level calculations are shown in Table 3. The only light that does not fall within the recommended range was the Sepco light.

Table 3 also summarizes the number of occasions when the solar-powered streetlights failed to provide a sufficient illumination throughout the night. It is separated by manufacturer, and provides insight into the functionality of these lights.

The output light intensity from the SC Solar streetlight proved to be the best. It was not only closest to the control light, but also fell within the recommended streetlight illumination guidelines. This manufacturer's light also provided sufficient nighttime duration on all but a few occasions. The SC Solar streetlight system's calculated efficiency was superior to the other two lights, as well.

The SOL output light intensity also fell within the recommended illumination guidelines, but failed to provide a sufficient nighttime duration on numerous occasions. The Sepco light never failed to last all night, but its illumination levels were the poorest, and were not within the recommended illumination guidelines.

Although the Sepco light's output was not within the recommended guidelines, it may be possible to change the light bulb to a different type, such as HID, in order to improve the illumination levels. Or, the wattage of the bulb could be increased to provide additional illumination. Similarly, another solar panel could be added to the SC Solar light to provide additional energy for the consecutive days when the exposure levels were low. This would address the duration issues, but may add a significant cost to the system.

Summary

This experiment proved that photovoltaic streetlights could be a viable alternative to standard utility-powered streetlights in urban environments. With a few exceptions, the energy stored during the day was sufficient to provide illumination throughout the night. The illumination that was provided was also shown to fall within the recommended ground level illumination guidelines of the IIESNA for two of the three manufacturers.

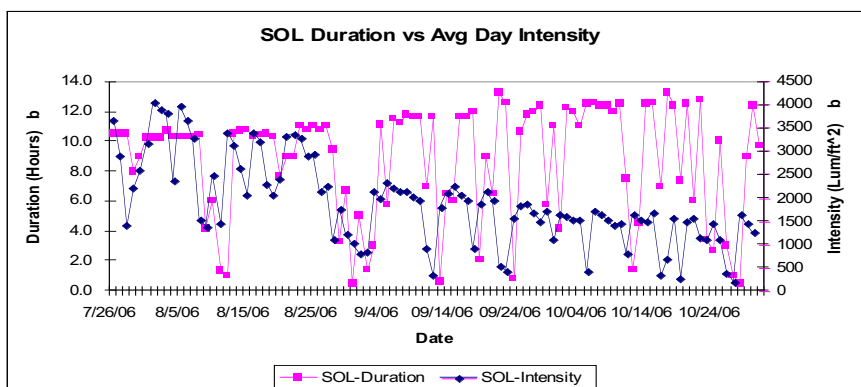

Figure 7. Durations and Average Day intensity for the SOL light.

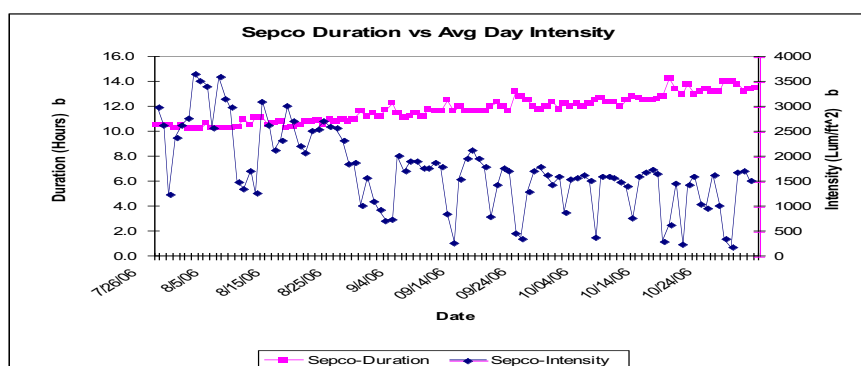

Figure 8. Durations and Average Day intensity for the Sepco light.

The author, Maria Dawson, is currently employed at Delta Services, LLC as an Assistant Project Manager. She holds a Bachelor of Science in Mechanical Engineering and a Master of Engineering in Mechanical Engineering, both earned at the University of Louisville's Speed School of Engineering.

References

Black, Tony. "The Party's (Almost) Over: "Peak Oil" and the Coming Global Energy Crisis." *Canadian Dimension* Sep/Oct 2005, Vol. 39, Issue 5: 14-16.

"Blinded by the Light." *Consumer Reports* Apr 2003, Vol. 68, Issue 4: 14.

Carts-Powell, Yvonne. "Research Targets More-Efficient Photovoltaics." *Laser Focus World* Jun 2006, Vol. 42, Issue 6: 119-123.

Costlow, Terry. "Solar Inches Forward." *Design News* 11/7/2005, Vol. 60, Issue 16: 35-39.

Davy, Emma. "Crude Awakening." *Current Science* 3/4/2005, Vol. 90, Issue 12: 4-5.

Guntermann, Alfred E. "The State of Energy: Then, Now, and in the Future." *Heating/Piping/Air Conditioning HPAC Engineering* Sep 2006, Vol. 78, Issue 9: 26-36.

Hirsch, Robert L.; Bezdek, Roger H.; and Wendling, Robert M. "Peaking Oil Production: Sooner Rather than Later?" *Issues in Science and Technology* Spring 2005, Vol. 21 Issue 3: 25-30.

Kammen, Daniel M. "The Rise of Renewable Energy." *Scientific American* Sep 2006, Vol. 295, Issue 3: 84-93.

Kunstler, James Howard; McPherson, Coco. "The End of Oil." *Rolling Stone* 4/7/2005, Issue 971: 45-48.

Livingston, Doug. "Easier Solar Power." *Mother Earth News Summer* 2006, Special Issue 215A: 122-126.

Long, Cheryl. "Easy Solar Power." *Mother Earth News* Oct/Nov 2006, Issue 218: 44-48.

Miles, R.W. "Photovoltaic Solar Cells: Choice of Materials and Production Methods." *Vacuum* Aug 2006, Vol. 80, Issue 10: 1090-1097.

Mooney, D.; R. Mitchell, E. Witt, R. King, and D. Ruby. "PV Manufacturing R&D Accomplishments and Status." *National Renewable Energy Laboratory* November 2003 NREL/TP-520-35278.

Overton, Gail. "Quantum Dots Promise Next-Generation Solar Cells." *Laser Focus World* Apr 2006, Vol. 42, Issue 2: 44-46.

Pierce, Alan. "Saving Energy One Lightbulb at a Time." *Tech Directions* Apr 2006, Vol. 65, Issue 9: 11.

Raloff, Janet. "Illuminating Changes." *Science News* 5/20/2006, Vol. 169, Issue 20: 314-316.

Repas, Robert. "Lighting Up the Night." *Machine Design* 9/15/2005, Vol. 77, Issue 18: 108-115.

Roman, Harry T. "Converting Sunlight to Electricity-Some Practical Concerns." *Tech Directions* Oct 2005 Vol. 63, Issue 3: 24-25.

Sanford, Jeff. "Powering Up Solar." *Canadian Business* 9/12/2005, Vol. 78, Issue 18: 41-42.

Symko-Davies, M. "Status of High Performance PV Polycrystalline Thin Film Tandems." *National Renewable Energy Laboratory* February 2005, NREL/CP-520-37379.

Woolley, Scott. "The Control of Light." *Forbes* 10/31/2005, Vol. 176, Issue 9: 70-72.

www.gelighting.com

www.oksolar.com

www.osram.com

Understanding the Impact of Asthma Among School-Aged Children

Maisah Edwards, MPH Candidate
Janelle Lefebvre, MPH Candidate

Sponsor: Veronnie Faye Jones
School of Public Health and Information Sciences
and School of Medicine
University of Louisville



Abstract

Background: Understanding health issues causing student absenteeism is important in developing targeted interventions. In Louisville, KY, a pilot project was undertaken at one Jefferson County public middle school in an effort to determine the impact of asthma on student attendance.

Objective: The aims of the project undertaken at a middle school located in southwestern Jefferson County, were 1) to identify students with signs and symptom suspicious for asthma using a standardized tool and compare with the traditional passive method used for identification by that school system; 2) compare and categorize student absences among those students who did not score positively on an allergy/asthma survey and those students who did score positively; and 3) explore the financial impact of asthma on one middle school.

Design/Methods: In collaboration with the school principal and the Partnership for a Green City, a multi-step process was initiated involving evaluation of existing attendance records, health records, and results from an asthma/allergy questionnaire administered by school personnel.

Results: Using traditional absenteeism monitoring information for the 2006-2007 school year, the school log revealed that 4562 absences occurred with 1431 (31.4%) of those being a collection of documented physical and/or behavioral reasons. 1022 of 4562 (22.4%) were noted as “sick” without explanation and 2109 of 4562 (46.2%) absences were due to reasons unknown as there was no information provided by parents/guardians. In order to drill down and more effectively determine the impact of asthma on absenteeism, a questionnaire was identified for use in order to provide more focused information. School personnel administered the questionnaire to 288 students in grades 6 and 7 present on a particular school day. Students in grade 8 were not surveyed as they would not be in attendance during the next school year and unable to participate in interventions. Of those in attendance, 288 completed the survey. For those completing the survey, 101

of 288 (35%) scored positively for known or suspected asthma with 101 of 288 indicating they currently use rescue inhalers. These 101 students accounted for 1118 absent days and over \$28,000 lost to that middle school through state funding.

Conclusions: Results from the student questionnaire revealed a significant gap on the part of the school regarding their knowledge of the numbers of students with asthma and its impact on school attendance. This pilot assessment demonstrates the need to better understand the impact of asthma on student school attendance in order to develop interventions targeted to this population.

Introduction

Asthma is one of the most common chronic childhood diseases causing constriction of the airways. Symptoms include: coughing during physical activity, or coughing throughout the day/night, chest tightness, feeling tired or out of breath, rapid breathing, and wheezing. Severe asthma “attacks” can cause temporary respiratory obstruction, low blood oxygen levels and even death. Asthma can disrupt sleep, the ability to concentrate, interfere with memory and/or classroom participation. National statistics show that students with asthma will have at least 3 more absences than children without asthma.

In 2005, the Asthma and Allergy Foundation of America ranked Louisville as the third worst city in the U.S. based on the factors of estimated and reported prevalence of asthma; asthma-related deaths; annual pollen level; annual air quality; public smoking laws; number of asthma specialists; school asthma-inhaler access laws; uninsured rate; and poverty rate.

Although there is little comprehensive data regarding asthma in Louisville, we do know that asthma has consistently been the number one diagnosis for children admitted to Kosair Children's Hospital (Louisville, KY). 2,984 children visited Kosair's emergency room for asthma-related problems in 2005.



Asthma often goes undiagnosed as the disease mimics the signs of a common cold. This often results in many absences for the student and loss of SEEK (Support Education Excellence in Kentucky) funding for the school.

Working with The Partnership for a Green City, a collaboration between the Jefferson County Public School (JCPS) system, the University of Louisville, and Metro Louisville, asthma project was undertaken to better understand the relationship between asthma and student attendance. O.M. Lassiter Middle School volunteered to serve as a model for other schools, which could lead to broad scoped interventions in other schools.

Lassiter Middle School is a designated JCPS Health Promotion School of Excellence with an emphasis on environmental issues. During the 2006-07 school year, Lassiter had an enrollment of just over 650 students in grades 6, 7, and 8. A review of the school's health records from the 2005-2006 academic year identified 17 students at Lassiter whose parents/guardian had returned the medication authorization form for asthma. This does not take into account children who are under-diagnosed, under-treated, or who do not provide the school with the required authorization form for medication use during school. The Lassiter student population is 43% female and 57% male; 62% Caucasian, 33% African American and 3% Hispanic. Seventy-seven percent of the students enrolled at Lassiter qualify for free or reduced lunches with a majority also qualifying for healthcare via Medicaid. Students attend Lassiter from six different zip codes in the Louisville metropolitan area with 62% of the students coming from two of those six areas, with one zip code (40211) being an area closest to the primary chemical industrial area known as Rubbertown. The other primary feeder zip code (40118) has one of the highest rates of hospital admissions for asthma.

Methods

The Lassiter project began with an evaluation of existing methods for monitoring student absence. The absentee logs for the 2005-2006 school year and 2 months into the 2006-2007 school year were evaluated to determine the reasons for absence. The method primarily used by the attendance clerk was based upon whether the absence was excused or unex-

cused. To the best of her ability, she documented as much information as was available to her regarding reasons for absence and went to great efforts to contact parents/guardians individually when written documentation regarding absence was not provided. Despite those efforts, the principal and school staff recognized that the information provided to them was not sufficient for use in drawing viable and useful conclusions.

STUDENT QUESTIONNAIRE			
Name _____	Age _____	Grade _____	Teacher _____
Race: <input type="checkbox"/> African American <input type="checkbox"/> Asian American <input type="checkbox"/> Hispanic <input type="checkbox"/> White <input type="checkbox"/> Native American <input type="checkbox"/> Other			
Please tell us how often you have any of the following:			
1. My breathing sounds noisy or wheezy.	<input type="radio"/>	<input type="radio"/>	<input type="radio"/>
	NEVER	SOMETIMES	A LOT
2. It is hard to take a deep breath.	<input type="radio"/>	<input type="radio"/>	<input type="radio"/>
	NEVER	SOMETIMES	A LOT
3. It is hard for me to stop coughing.	<input type="radio"/>	<input type="radio"/>	<input type="radio"/>
	NEVER	SOMETIMES	A LOT
4. My chest feels tight or hurts after I run, play hard, or do sports.	<input type="radio"/>	<input type="radio"/>	<input type="radio"/>
	NEVER	SOMETIMES	A LOT
5. I wake up at night coughing.	<input type="radio"/>	<input type="radio"/>	<input type="radio"/>
	NEVER	SOMETIMES	A LOT
6. I wake up at night because I have trouble breathing.	<input type="radio"/>	<input type="radio"/>	<input type="radio"/>
	NEVER	SOMETIMES	A LOT
7. I cough when I run, climb stairs or play sports.	<input type="radio"/>	<input type="radio"/>	<input type="radio"/>
	NEVER	SOMETIMES	A LOT
8. My eyes get itchy, puffy or burn.	<input type="radio"/>	<input type="radio"/>	<input type="radio"/>
	NEVER	SOMETIMES	A LOT
9. I have problems with a runny or stuffy nose.	<input type="radio"/>	<input type="radio"/>	<input type="radio"/>
	NEVER	SOMETIMES	A LOT
Please answer the following questions:			
10. A doctor or nurse told me that I have asthma.	<input type="radio"/>	<input type="radio"/>	
	YES	NO	
11. I stayed in the hospital overnight for asthma or trouble breathing this past year.	<input type="radio"/>	<input type="radio"/>	
	YES	NO	
12. I take medicine or use an inhaler for asthma.	<input type="radio"/>	<input type="radio"/>	
	YES	NO	
13. I take medicine for allergies.	<input type="radio"/>	<input type="radio"/>	
	YES	NO	
SUGGESTED SCORING KEY			
Asthma:	For Questions 1 through 7, assign a "1" for each "sometimes" or "a lot" response. Add the scores. If the total is 3 or more, referral for asthma diagnosis may be indicated. A total score of 3 has an estimated sensitivity of 80% and specificity of 70%, according to the clinical predictability of the questionnaire in a validation study.*		
Allergy:	For Questions 8 and 9, assign a "1" for each "sometimes" or "a lot" response. Add the scores. If the total is 1 or more, referral for allergy diagnosis may be indicated. A score of 1 has an estimated sensitivity of 81% and specificity of 42%, according to the clinical predictability of the questionnaire in a validation study.*		

* Ann Allergy, Asthma Immunol. 2004;93:36-48. Copyright 2004. Permission is hereby granted for the reproduction of this questionnaire as it appears for use by school-based allergy and asthma screening programs.

Figure 1.



The principal requested assistance in identifying an alternative method that could be used in gathering health-related data for a more in depth analysis. Researchers from the University of Louisville School of Public Health and Information Sciences (UL SPHIS) investigated a variety of assessment tools that could be used as a student questionnaire. A tool was identified that had been previously used in other cities to screen for asthma (Figure 1). The principal then developed a distribution process so all of his sixth and seventh grade students in attendance on a single day were given a questionnaire to complete during a pre-determined class time. UL SPHIS researchers performed analysis of data but

did not participate in the survey distribution process. Review and approval of the process was done through the University of Louisville Human Studies Protection Office and exempt status was indicated by the Institutional Review Board.

The Family Resource and Youth Services Coordinator gathered the completed 288 student questionnaires, and then assigned a unique identification number for each questionnaire. The de-identified questionnaires were then given to the UL SPHIS researchers for analysis using SPSS 15.0.

Question	Positive Score – Suspicious for Asthma	Negative Score- Not Suspicious for Asthma	p-value
Score	101/288 (35.1%)	187/288 (64.9%)	<0.001
Noisy breathing	66/101 (65.3%)	19/187 (10.2%)	<0.001
Hard to breathe deeply	60/101 (59.4%)	9/187 (4.8%)	<0.001
Hard to stop coughing	75/101 (74.3%)	32/187 (17.1%)	<0.001
Chest tight after exercise	88/101 (87.1)	56/187 (29.9%)	<0.001
Wakes up coughing	54/101 (53.5%)	21/187 (11.2%)	<0.001
Wakes up with breathing difficulty	32/101 (31.7%)	2/187 (1.1%)	<0.001
Coughs with exertion	70/101 (69.3)	19/187 (10.2%)	<0.001
Told they have asthma by MD or nurse	39/101 (38.6%)	19/187 (10.2%)	<0.001
Overnight hospitalization for asthma during past year	8/101 (7.9%)	3/186 (1.6%)	0.008
Uses inhaler	31/101 (30.7%)	17/186 (9.1%)	<0.001
Takes allergy medication	60/101 (59.4%)	35/184 (19%)	<0.001

Table 1: Student responses stratified by whether the student scored positively or negatively as suspicious for asthma on the screening survey.



Results

In reviewing the student absenteeism log during those time periods, a total of 4562 absences were identified; 31.4% were from different physical and behavioral reasons that had been provided by their parent/guardian. These specific reasons included illnesses such as fever, headache, asthma, nausea and vomiting, etc., and behavioral issues including oversleeping, unable to get up for class, ran away, suspended, in jail, etc. 22.4% were “sick” (no specific reason), and 46.2% had an unknown reason for absence (attendance clerk unable to talk with parent/guardian, or they were unable to give a specific reason for the absences). Since Lassiter was aware of 17 individual students with an asthma authorization form, it was expected to see asthma noted frequently on the list of reasons for absences, but it was not.

When evaluating the de-identified questionnaires completed by the students, the scoring was based upon the directions provided by its developers as was printed on the questionnaire. A student scoring 3 or more met the criteria for suspicion of asthma with an estimated sensitivity of 80% and specificity of 70%, according to the clinical predictability of the questionnaire in a validation study. Table 1 shows the student questionnaire responses stratified by whether the student answered questions indicating suspicion for asthma. Results show 101 (35.1%) of the 288 children surveyed had a positive score indicating a suspicion of asthma. The majority of the 101 students claimed to experience the majority of the asthma-related symptoms asked about in the questionnaire as shown in Table 1. 38.6% of the students with positive scores had been told by a healthcare professional that they have asthma, although only 17 students in the entire school reported having asthma using the school’s passive reporting process. Another finding was that 30.7% of students scoring as suspicious for asthma reported using an inhaler. Comparison data among the surveys and record of absenteeism also showed that these 101 students accounted for 1118 of the 4562 absent days.

Discussion

Results from the student questionnaire revealed a significant gap on the part of the school regarding their knowledge of the numbers of students with asthma and its impact on school attendance. The school was aware of 17 students indicating they have asthma out of the 650 total student body. The questionnaire revealed a striking contrast in that 101 (35.1%) students scored positively on this asthma screen. Results also show that 39 (38.6%) of the 101 children reported that they were told by a physician that they have asthma, indicating that at least 22 parents failed to include this information in the child’s school medical information. 30.7% of children from the same group also report using an inhaler.

Most children with positive scores showed significant responses to the questions about asthma related symptoms and several of those may impact the ability of the students to actively participate in the classroom. For example, 31.7% report waking up at night with difficulty breathing.

Although the majority of the results in this study were statistically significant, one limitation is that this study was a pilot study done at a single school. This study needs to be repeated at other schools in order to provide external validity.

One other limitation of this study is that students were given the survey during the spring when complications from asthma and allergies may be escalated. In order to make the results more generalizable, future studies should distribute the survey at various times throughout the year.

Overall this study implies that asthma may be seriously under-diagnosed in children leading to severe under-estimates of its impact on student absenteeism. This pilot assessment demonstrates the need to better understand the impact of asthma on student school attendance and develop targeted interventions that may promote student attendance and minimize lost classroom time and educational funding for schools.

The authors wish to thank Professor David J. Tollerud, MD, MPH; Veronnie F. Jones, MD, and Ruth Carrico for their assistance and guidance in conducting this research.

References

- Ann Allergy, Asthma Immunol. 2004;93:36-48.
- Kosair receives grant for asthma education program. (2006, July 28). *Business First*, Retrieved August 23, 2006 from <http://louisville.bizjournals.com/louisville/stories/2006/07/24/daily45.html>
- Redline S, Gruchalla R, Wolf R, Yawn B, Cartar L, et al. Development and validation of school-based asthma and allergy screening questionnaires in a 4-city study. *Annals of Allergy, Asthma and Immunology* 2004;93:36– 48.
- Salley, V. (2005, March 1). *Out of Breath: Childhood Asthma, Poverty and Housing*. Retrieved August 21, 2006, from the Metropolitan Housing Coalition Web site: http://www.metropolitanhousing.org/pdf/mhcdoc_80.pdf
- Warner, J. (2005, February). America’s worst asthma cities. *MedicineNet.com*. Retrieved from <http://www.medicinet.com/script/main/art.asp?articlekey=43547&pf=3&page=1>



Mercury Regulation: The Clean Air Mercury Rule in Kentucky

Caroline Chan, MPH

Abstract

Mercury is a potent toxin. The primary source of human exposure is through consumption of fish contaminated with methylmercury. Methylmercury exposure is particularly damaging to developing fetuses. Methylmercury damages the nervous system, resulting in lowered cognitive impairment and other neurological effects. Because mercury has become so pervasive in the environment, efforts to regulate emissions have become necessary. Currently, the largest source of anthropogenic mercury emissions in the US is from coal-fired power plants (EPA, 2006a). Under the Clinton Administration, these emissions were to be regulated as a hazardous air pollutant. When the Bush Administration came in to office, the Clinton plan was derailed, and in its place, the Clean Air Mercury Rule (CAMR) was promulgated. The CAMR regulates mercury emissions with a cap and trade program.

This paper examines the positive and negative aspects of the CAMR in light of the constraints it places on the State of Kentucky in its efforts to regulate mercury emissions to protect human health. Issues to be considered are cost benefit analyses, creation of hotspots, emissions that cross into Kentucky's borders, and the appropriate level of government regulation of mercury emissions.

Background

Mercury has been confirmed toxic to humans. Environmental disasters have occurred in Minamata, Japan and Iraq resulting in neurological symptoms and fatalities. Of particular note was the unusual number of children born with cerebral palsy and mental retardation when milder or no symptoms were observed in the mothers. The evidence indicating that fetuses are more susceptible to mercury exposure than adults is strong (Harada, Masazumi et al., 1999). The 1999-2000 National Health and Nutrition Examination Survey (NHANES) found that approximately 8% of women of childbearing age had blood mercury levels equal or greater than the EPA's reference dose, which is the level considered safe (EPA, 2006e). This indicates that large numbers of developing fetuses are at risk from mercury exposure.

Humans are exposed to mercury in many ways. Dental amalgams, broken thermometers, and some vaccines are common routes of exposure. However, the primary source of exposure in humans is the consumption of fish contaminated with methylmercury. Fish is a lean source of protein and is a vital source of nutrition for many individuals. It is beneficial to nervous system development, and therefore is recommended as a source of nutrition (Clarkson, Thomas W. and Strain, J. J., 2003). Subsistence fishermen rely on fish from local waterways to provide a considerable portion of their dietary needs. They are at particular risk for harm from mercury exposure.

In order to reduce human exposure to mercury, reducing methylmercury levels in fish tissue is essential. Understanding the source of mercury in fish tissue, however, is complicated. Methylmercury in fish tissue begins with inorganic mercury in the atmosphere. Inorganic mercury is emitted by a number of processes. Natural sources of inorganic mercury include volcanic activity and soil erosion. This accounts for about one third of the atmospheric mercury. The remaining two thirds comes from anthropogenic sources (EPA, 2006c). Approximately half of this is from reemission of previously deposited mercury, and half from new sources. Coal burning power plants are the largest source of anthropogenic emissions in the United States (EPA, 2006c).

Mercury in the atmosphere is found in three forms: elemental gaseous mercury, reactive gaseous mercury, and particulate bound mercury. The particulate bound mercury is thought to be only a small portion of the atmospheric pool, and quickly settles to land. The elemental gaseous mercury and reactive gaseous mercury convert back and forth between the two forms, but the elemental gaseous mercury is more stable and frequently becomes global, while the reactive gaseous mercury is soluble in water and will deposit in rain through a process called wet deposition (Lindberg, S. et al., 2007). After the inorganic mercury deposits as particulate matter or wet deposition, it washes into waterways where it settles in the sediment. Once in the sediment bacteria transform the inorganic mercury into methylmercury, a form that is readily absorbed into cells because of the character-



istics of cell membranes. The methylmercury bioaccumulates and magnifies in the food chain, and is highest in predatory fish (EPA, 2006e). Mercury is considered a highly toxic, persistent bioaccumulative pollutant.

Coal-fired power plants comprise the largest source of new anthropogenic emissions. Therefore, reducing human exposure to mercury entails reducing atmospheric mercury by regulating anthropogenic stack emissions. Previously, medical waste and municipal waste incinerators contributed substantial amounts of mercury to the atmospheric pool, but regulatory controls have been placed on these sources, and emissions have been reduced by over 90% (EPA, 2006).

History of policy development

Section 112 of the 1990 Amendment to the Clean Air Act addresses hazardous air pollutants (HAPs). Under Section 112, the administrator is required to promulgate emission standards that result in the maximum degree of reduction in pollutants that are named HAPs. The amendment mandates that standards be promulgated for designated HAPs within ten years, and that compliance with those standards be achieved within three years of the standard being set. Mercury compounds are one of the pollutants named as a HAP (Clean Air Act: Section 112, 1990). The outcome of this designation is that major sources of mercury emissions were required to be regulated with the maximum achievable control technology (MACT). This type of regulation is called command and control. The administrator dictates which form of technology is used to control emissions.

In 2000, under the Clinton administration, the EPA was ready to begin regulating mercury in power plants with MACT (EPA, 2006d). It was believed that existing technology would be able to reduce mercury emissions from coal and gas burning power plants by 90%, from 48 tons to about 5 tons per year (Shore, M., 2003).

With the election of George W. Bush, the regulation of mercury emissions by MACT was put on hold. Industries challenged the regulation of mercury under Section 112 of the Clean Air Act. In 2002, President Bush proposed to Congress the Clear Skies Initiative. This legislation would regulate mercury, as well as sulfur dioxide and nitrogen oxides, by a cap and trade program (EPA, 2007b). Congress failed to pass the Clear Skies Initiative, leading in January of 2004 to the EPA, with the backing of the president and energy industry, to reconsider the December 2000 ruling that it was “appropriate and necessary” to regulate mercury emissions under Section 112. Instead, the EPA recommended that mercury be regulated under Section 111 which regulates pollutants by establishing “standards of performance.” Unlike MACT, the technology to achieve that standard is not mandated (Clean Air Act: Section 111, 1970). A standard of performance requires that emissions of a particular pollutant not exceed a certain “standard”, or level, but it is up to the industry to determine how to comply with the given standard. In March of 2005, the EPA issued the Clean Air Mercury Rule (CAMR) as a means of regulating mercury to bypass the inaction of Congress in passing the Clear Skies Initiative. This action shows the power of the energy lobby in that mercury emissions from coal-fired power plants are regulated by “standards of performance”, while mercury emissions from industrial boilers, hazardous waste combustors, the chlor-alkali sector, and iron and steel foundries are regulated under Section 112 with MACT (EPA, 2007b). In other words, a special exemption was granted to coal-fired power plants side stepping the tougher regulations imposed on other industries.

The CAMR establishes a cap and trade program for mercury emissions from coal burning power plants. It has two phases. The first phase is achieved by a co-benefit reduction of mercury emissions through the regulation of sulfur dioxide and nitrogen oxides by the Clean Air Interstate Rule (CAIR), another cap and

trade program established by the Bush Administration. This phase caps mercury emission at 38 tons by 2010. This reduction would be achieved by complying with the CAIR. The second phase begins in 2018, and caps mercury emissions at 15 tons and is achieved through any means the facility deems appropriate.

Cap and trade programs for pollutant emissions have gained popularity after the success of the Acid Rain SO₂ Program. The policy of cap and trade relies on the idea that industries will find the most cost effective mechanism to lower emissions if they are required to lower emissions, but are given the flexibility to choose the method of reduction. Market based incentives are applied through a trading program. Allowances can be bought and sold on a commodities market. The ability to profit from selling allowances is an incentive to reduce emissions. The EPA estimates that the cost of each mercury allowance on the national market will be approximately \$1697 in 2010, \$2201 in 2015, and \$2855 in 2020 (EPA, 2006b). The success of the Acid Rain SO₂ Program has made market based policy initiatives attractive to lawmakers and industry.

The CAMR allocates each state a mercury emissions budget. The state then determines the allocation of this budget between the various coal-fired utilities within the state. The information management, emissions data reporting, and allowance trading are carried out online, using the Acid Rain SO₂ Program as the model. Compliance penalties result in the surrender of allowances sufficient to offset excess emissions and in addition the surrender of allowances from the next control period of three times excess emissions (CAMR, 2007).

Kentucky's Approach to Mercury Emissions

Each state may decide to participate in the EPA's market program, or submit to the EPA a program that promulgates a level of mercury emissions at levels at least as stringent as the allocation the EPA



established for that state. Because of pressure exerted by the energy industry to regulate emissions by the means that is least costly to industry, most states are expected to participate in the EPA market. Kentucky has chosen to participate in this system.

Coal mined in Kentucky fuels 95% of Kentucky's electric energy, and it appears it will remain a major economic force for the state for years to come (Weisenfluh, G. A. et al., 1996). Industry representatives seek to minimize costs as they maximize profits. The CAMR is seen as a cost effective means of regulating mercury emissions. In particular, purchase of new technology to reduce emissions levels can be postponed until 2018, or whenever convenient with the purchase of allowances on the market. Kentucky's allocation for the years 2010 through 2017 is 1.525 tons (3050 pounds) (CAMR, 2007). The cap for Kentucky beginning in 2018 is lowered to 0.602 tons (1204 pounds). Section 112 regulation of mercury proposed to reduce national emissions from 40 tons per year to 5 tons per year, and was to be accomplished by 2008. In contrast, the CAMR rule lowers emissions by 70% by 2018 (Shore, 2003). The CAMR is far more attractive to the powerful coal and energy industry lobbies than the earlier MACT policy. Given coal's importance to Kentucky, state government gives great weight to the requests of that industry.

The allocation of allowances is described in 401 KAR 60.020, Kentucky's Mercury Budget Trading Program (Kentucky Legislative Research Committee, 2007). This administrative regulation dictates that Kentucky shall follow the plan set forth by the CAMR as defined in the Code of Federal Regulations (40 C.F.R. 60.4101 to 60.4176). This legislation also stipulates that the standards set by the state will not be more stringent than federal standards. Kentucky defines each allowance as an ounce, with the total number of allowances equal to the cap (48,800 ounces from 2010 through 2017, and 19,264 ounces from 2018 and thereafter). The total number of allowances is split

into two pools, with 2% being reserved for sale by the state, and the remaining 98% distributed to existing coal-fired electric utilities. The distribution is determined by a formula that takes into account the average energy output of each utility during the years 2001 through 2005 (Kentucky Legislative Research Committee, 2007).

Despite the prominence of the coal and energy industry in Kentucky's politics, the problem of mercury exposure to the public is taken seriously. Fish tissue levels of mercury are regularly out of compliance with human health criterion, resulting in statewide fish consumption advisories. The Kentucky Environmental Quality Commission (EQC) held a public meeting on the issues of mercury in the environment. The EQC is a citizen's advisory board to the Governor that works to give the public a voice in addressing environmental problems (EQC, 2006). The EQC issued recommendations to the Governor in the document, "Mercury in Kentucky: A Public Dialogue of Issues and Needs, Based on the findings of the May 17, 2004 EQC Public Meeting." It called on the Governor to address the needs of the public in protecting them from mercury exposure, as well as gathering more information to better understand the risks that mercury in the environment poses (Ormsbee, L. et al., 2004).

Previous Governor Ernie Fletcher created the Mercury Task Force to respond to the EQC's recommendations. The task force was comprised of individuals from various branches of government, including the Environmental and Public Protection Cabinet, the Kentucky Cabinet for Health and Human Services-Department for Public Health, and the Department of Fish and Wildlife Resources. The task force published a response in September, 2006 entitled, "Mercury Task Force Report to the Environmental Quality Commission." Five recommendations were issued to address this complex problem: "1) inform and educate the public about the risks of mercury in fish, 2) target additional outreach efforts at high-risk areas, 3) strengthen testing and analysis of mercury

in the environment, 4) strengthen environmental health surveillance and 5) reduce persistent, bioaccumulative and toxic (PBT) chemicals" (EPPC, CHFS, and Commerce Cabinet, 2006). The fifth recommendation is the only item that addresses the problem of mercury reduction by suggesting the state should minimize the pollutant in the environment rather than telling people how to avoid being exposed or further researching the extent of the problem. While the other four recommendations have specific action items in the report, recommendation five to reduce persistent, bioaccumulative and toxic chemicals, of which mercury is one of 22, does not indicate how to accomplish this important step (EPPC, CHFS, and Commerce Cabinet, 2006).

Policy Analysis

Emissions trading programs have been shown to be a cost effective and successful method of regulating emissions. The transition to cap and trade from command and control can be difficult. The administrative approaches differ significantly. In command and control, the regulator must be knowledgeable about the technology required. Compliance is monitored by inspection of needed components in the system, and proof that they are installed and working correctly. Actual emissions are not measured, and so the effectiveness of the equipment is not demonstrated. The purchase of equipment is a cost to industry. This is often a one time lump sum, and can be substantial, particularly when a new technology is mandated, and demand for this equipment suddenly becomes high. With a cap and trade program, continuous emissions monitoring (CEM) is required to verify the actual amount of emissions. The responsibility and cost of reporting emissions is placed on industry. The administrator is responsible for interpreting and calculating whether or not emissions are in compliance. The purchase of monitoring equipment is an initial cost, and the ongoing monitoring, data management and reporting that this monitoring entails is a cost that industry must cover (Tietenberg, T. H., 2006).



The costs of the two systems are also spread differently over time. With cap and trade, the initial allowances are almost always distributed by the state gratis. This gives existing industry a substantial advantage over new sources that are generally required to purchase allocations from existing sources. This may prove detrimental to the overall goal of reduction, because it discourages the construction of new sources which generally install new, cleaner technology. Kentucky is a state that leaves new sources with the disadvantage of having to purchase allowances from the state or existing sources.

In the special case of mercury, cap and trade has been criticized by some because the mercury deposits both locally and globally. Because the buying and selling of allocations occurs over a large area, purchasing of allocations can occur where sources may be clustered and create local “hotspots” of mercury contamination. This may result in certain populations being unfairly burdened with mercury exposure compared to other populations where coal-fired power plants are not located, or have installed technology to remove the pollutant.

A presentation at the American Public Health Association conference in Washington, D.C., found that channel catfish downwind from coal-fired electric utilities had methylmercury levels that were up to 19 times higher than store bought fish, which was up to eight times higher than the EPA’s acceptable risk level of methylmercury for children (Volz, C. et al., 2007). This study suggests that even though most atmospheric mercury is from global sources, local sources do have a significant impact downwind from the emission site. If the purpose of the cap and trade program is to lower mercury levels in the environment to levels that protect human health, then the cap and trade program must address the issue of the distribution of emission sources and the level of mercury emissions when sources are clustered. As the CAMR is written, it does not address this issue. Beyond that, it specifically forbids states from placing limits on the geographic distribution of where allowances are bought and sold (EPA, 2007a). Because the distribution of allowances cannot be regulated, the potential for mercury hotspots is real.

This inequitable distribution of pollutants can be seen in the example of Southern Indiana’s “sacrifice zone” (Valley Watch, 2006). Hospitalization for asthma in Vanderburgh County, Indiana (Evansville) during 1994-1995 were 4.7 per thousand, while in Fort Wayne, Indiana, hospitalization rates were 2.5 per thousand (Partnership for Healthcare Information, 1998). A look at the distribution of power plants in Indiana, Figure 1, quickly reveals that pollution from the clustering of power plants in southern Indiana is a likely cause of the difference in hospitalization rates between the two cities in Indiana. While mercury emissions do not cause asthma, the example demonstrates the inequitable effect that local emissions from the clustering of pollutant sources in Southern Indiana has on human health.

Southern Indiana emits far more total mercury (and other) pollutants from electric utilities than Kentucky, and these utilities

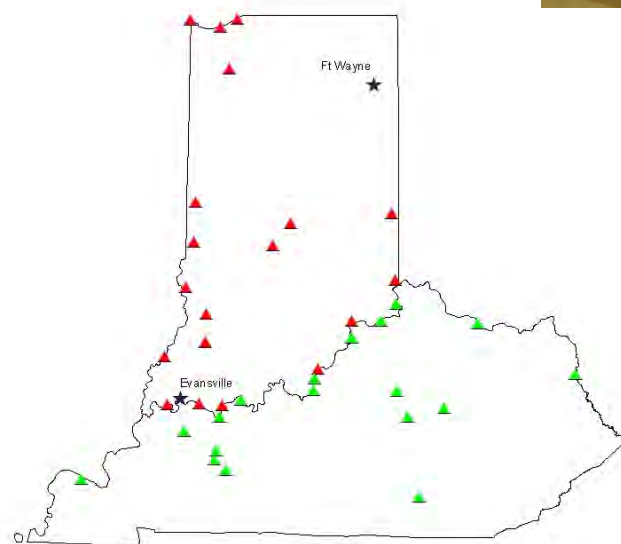

Figure 1. Coal-Fired Electric Utilities in Indiana and Kentucky.

are located primarily in the southern portion of the state. Based on the 2005 Toxics Release Inventory data, Kentucky’s largest source of mercury emissions was the TVA Paradise Fossil Plant with 490 pounds of mercury emitted. Three facilities located in Southern Indiana emit more than the TVA Paradise Fossil plant, with one of these plants emitting 1179 pounds (EPA, 2006f). Because prevailing winds are from the southwest, the emissions from these power plants frequently blow into Kentucky, placing the residents of Kentucky at risk for exposure.

The CAMR specifically forbids states that participate in the EPA sponsored trading program from placing restrictions on the geographical distribution of the allowances that are bought and sold. Within its own borders, a state can limit the allocation of allowances by retaining some of the allowances and placing limits on where new sources can locate. The state cannot, however, limit facilities from purchasing more allowances from another state (EPA, 2007a).

A state cannot place limits on how a neighboring state distributes its allowances or where it allows facilities to locate. These limitations may encourage states to place facilities on borders where emissions blow out of their own political boundaries into the area of another state. This permits the state to protect the health of the citizens in its own jurisdiction, while also helping it meet certain ambient air standards. The state receiving the emissions has no recourse to stop this action, and may have hotspots that endanger its citizens.

Economists have developed zonal cap and trade programs that address the problem of clustering of pollution sources and the resultant hotspots created. These zonal permit programs place caps in each zone. Trading is not restricted within a zone, but between zones trading is forbidden or a weighting system is used to discourage heavier emissions in regions that are already significantly impacted. Zonal permit programs require far more control



authority to regulate. The CAMR specifically forbids limits on trading, so this option to prevent clustering and hotspots is not available.

Regardless of the distribution of the sources of mercury emissions, the level of mercury emissions must be low enough to begin to reduce levels of methylmercury in fish tissue. The EPA has set the cap for the years 2010 to 2017 at 38 tons and 2018 and thereafter at 15 tons. In Kentucky, the level of mercury in fish tissue continues to be at levels that are above the human health criterion. In 2005, the latest year available, Kentucky's mercury emissions were 3491 pounds (EPA, 2006f). CAMR mandates that by 2010, Kentucky's emissions be reduced to 3050 pounds. The emissions reductions required for the first phase of CAMR are negligible. Indiana had mercury emissions of 5047 pounds in 2005 (EPA, 2006f). It has a 2010 cap of 4194 pounds (Legislative Services Agency, 2007) which is also a negligible reduction. These levels do not significantly lower mercury levels until Phase II of the program, and therefore will not have a positive impact on pollutant levels in the environment for some years.

To be effective, a cap and trade program must consider two components, first that the cap is placed low enough to reduce pollutant levels to an acceptable level for human health, and second, that the cost of the allowance is high enough to encourage the industry to lower its emissions, rather than purchase more allowances. The cost of each allowance on the national market will be approximately \$27,152 per pound in 2010, and \$45,680 by 2020. The cost of allowances on the market compared to the cost of installing equipment to reduce emissions will become more favorable toward equipment purchase as the cap is lowered in 2018. However, the cost of allowances during Phase I may not encourage early action in reducing emissions. The EPA believes that this time during Phase I will allow facilities the necessary time to install technological equipment to lower emissions (EPA, 2002).

When doing a cost benefit analysis, it is difficult to account for all the costs that a pollutant places on society. Trasande, Schechter, Haynes, and Landrigan (2006) examined neurological effects also and included not only health care costs but also loss of lifetime earnings due to IQ loss. Their conclusion was that each birth year's cohort in the US had a total loss of \$8.7 billion from mercury exposure in utero, with the \$1.3 billion of that being from US power plant emissions. Each excess case of mental retardation was a lifetime cost of \$1.25 million (Trasande, L. et al., 2006).

A cost benefit study was undertaken by Thomas W. Easterly, the Commissioner of the Indiana Department of Environmental Management, to determine if MACT or the CAMR was a more cost effective way to reduce the impact of mercury on human health. Dollar values were placed on the impact to human health per pound of mercury emitted from previously published studies, and the benefit of removing that exposure was then calculated. Two of the health outcomes Easterly examined were loss of IQ

Region	Loss of IQ	Mental Retardation
US	\$1.5 billion	\$289 million
Indiana	\$30 Million	\$6 million
From Indiana emissions	\$78 million	\$15 million

Table 1. Value of Health Benefits.

and mental retardation (Easterly, T. W., 2006). The total costs of mercury exposure to these health outcomes are reported in Table 1. Of note is the fact that Indiana's emissions negatively impact populations outside of its borders more than those within.

The result of the cost benefit analysis comparing the cost of MACT to CAMR, was a recommendation from the Commissioner that the CAMR be followed because it was more cost effective. The analysis noted that the EPA believes that a 69% reduction in US mercury emissions will result in only a 10% reduction in US mercury deposition, and have a very small impact on ocean species of fish which comprise the largest portion of US fish consumption. He also noted that this reduction will only benefit the small percent of the US population that consume local fish (Easterly, T. W., 2006). While it is true that only a small portion of the US population regularly consumes fish from local waters, subsistence fishermen can be severely impacted by mercury exposure, and the presence of consumption advisories on many of the nation's waterways deters individuals from consuming this source of food. A reduction in fish tissue methylmercury levels would probably result in an increase in the population that consumes this food source.

Easterly justified his recommendation in support of the CAMR with a statement on values. He used the example of fatal heart attacks to make his point: "avoiding a fatal heart attack is valued [sic] at \$6,000,000 while average lifetime earnings are about \$1,000,000—while people may be willing to pay \$6,000,000 to avoid a heart attack, they cannot afford to pay that much" (Easterly, T. W., 2006). The presumption that an individual having the heart attack should pay the cost to avoid it is flawed.

While Easterly's presentation detailed some of the health costs associated with mercury emissions, neurological damage creates a chain reaction of costs that are staggering when quantified. His final recommendation was based on balancing the cost of cleaning up emissions with his estimate of savings in health care costs. In many ways, this is not a valid rationale for making a decision. A dollar value cannot be placed on loss of cognitive function in a child. The entity responsible for the outcome should bear responsibility for paying for the damage. Currently, the cost of injury caused by environmental exposures is borne by society. These costs are spread between private and public health insurance, public school systems, government intervention programs, and the families bearing the burden of adverse outcome. The liability for the health care costs resulting from injury caused by



emissions has never been placed completely on the industry responsible. The inability of science to directly determine the cause of a given outcome after exposure has given industry a free ride from paying for the consequences of its emissions. Industry continues to use scientific uncertainty to avoid responsibility for the damages caused by emissions. The polluter pays principle would give industry the responsibility for paying these costs; both for health care and environmental clean up (Sands & Peel, 2005). If shareholder profits were decreased \$1,250,000 for every excess case of mental retardation, then industries would install control equipment as quickly as the equipment becomes available.

Cap and trade programs have been shown to be an effective incentive to industry to reduce emissions of pollutants. However, cross border pollution places states in the position of having no means to reduce contaminant levels. The CAMR does not address this problem. Clearly, states cannot regulate outside their borders, and the federal government has chosen not to address this problem. The level of government required to regulate this cross border problem must be above the level of the state. One solution might be to form regional regulatory agencies to address the problem. Regional governing has been effective in some situations. One example is the Ohio River Valley Water Sanitation Commission (ORSANCO). This regional governing body is comprised of the eight member states that border or contain the Ohio River and its tributaries. ORSANCO serves to improve the water quality of the Ohio River, and must report to the governor's and legislative bodies of its member states, as well as their congressional delegations (ORSANCO, 2003). Creation of a regional air quality commission may allow states to work together to address the issue of interstate pollution. The creation of a zonal trading program might be an effective regional program to address the problem; however, the CAMR strictly forbids the geographic limiting of trades. With this restriction, a regional commission may only be beneficial in locating new sources in areas that are not already impacted.

An even larger issue to consider is that a significant portion of atmospheric deposition of mercury comes from global sources. Even if all US mercury emissions were eliminated, global sources would continue to impact the health of the US population through deposition in the US and the oceans. At this time, an international treaty on reducing mercury emissions seems unlikely. China emits tremendous amounts of atmospheric mercury, and their demand for energy continues to grow. Since coal is abundant and cheap in China, these emissions are likely to grow (Wu, Y. et al., 2006).

The US has shown great reluctance to enter into any international environmental treaties that restrict economic growth or energy consumption. The likelihood of the US leading the world in demanding a reduction of this pollutant is unlikely with the George W. Bush administration. The energy lobby has demonstrated great power in influencing legislation within the nation as well as the negotiation process the US follows for international

agreements (DeSombre, E. R., 2005). The influence business has on the legislative process in the US makes it difficult to regulate many pollutants.

DeSombre suggests that the US is reluctant to enter international environmental treaties if the regulatory procedure is substantially different from domestic regulations. However, she also notes that once a pollutant is regulated domestically, the US will more likely be willing to agree to regulate that pollutant at the international level, particularly when the method of regulation in an international treaty is similar to how the US regulates at home. This suggests that a logical means to achieving global mercury emission reductions is to first develop and establish a mercury reduction program domestically. The CAMR, while criticized for not being stringent enough, does serve to regulate mercury emissions, and therefore may be an important step toward bringing an international treaty to fruition.

Because the state of Kentucky has little control over emissions outside of its borders, the state must find ways to protect the population from exposure in other ways. The Mercury Task Force recommendations to the EQC address this need. Educating the public and additional targeted outreach efforts to high-risk areas will help prevent exposure and thereby protect human health. Perhaps it is the only means the state has at this time. Strengthening testing and analysis of mercury, and health surveillance efforts may provide additional information on how significantly local environmental exposures impact the local population. Action steps for reducing contaminant levels may have to wait until the US is ready to be a leader at the international level.

Conclusion

Because mercury is such a potent toxin, it is necessary to substantially reduce levels in the environment. The political will has not yet developed to address this issue effectively. The CAMR will not do enough to protect human health. Phase I of the CAMR reduces emissions by only a negligible amount. The market system prohibits restricting the geographic distribution of allowances, creating the potential for hotspots. The state of Kentucky addresses this shortcoming by making a priority of educating the public about the dangers of methylmercury from fish consumption. The coal and energy industry hold significant political power in Kentucky as well as the nation's capital. While industry applauds the use of market based regulation of pollutants, the CAMR does too little to effectively reduce contamination levels. In order to have a significant reduction in mercury contamination, the problem of regional and global sources must be addressed. The CAMR forbids the concept of zonal regulation of mercury emissions, and it seems unlikely that the US will lead in the international front. However, for the first time, mercury emissions from electric utilities are being regulated. If viewed as a first step in moving toward more stringent national and eventually international regulation, then perhaps the CAMR becomes acceptable.



Caroline Chan received her Master of Public Health with a concentration in Environmental and Occupation Health in the spring of 2007 from the School of Public Health and Information Sciences. Her interests include all aspects of environmental mercury in areas such as risk assessment, human health effects, fate and transport, and federal and state regulations. She continues to explore this public health issue as a PhD student in SPHIS's Department of Environmental and Occupation Health Sciences.

References

- Clean Air Act: Section 111, 42 U.S.C. 7411. (1970). Available at: <http://www.epa.gov/air/caa/caa111.txt>
- Clean Air Act Amendment of 1990: Section 112, 42 U.S.C. 7412. (1990). Available at: <http://www.epa.gov/air/caa/caa112.txt>
- CAMR. (5-18-2007). Standards of performance for new and existing stationary sources: Electric utility steam generating units: Final rule, 40 CFR Parts 60, 72, and 75. Available at: http://www.epa.gov/ttncaaa1/t3/fr_notices/27982camr111.pdf
- Clarkson, T. W. & Strain, J. J. (2003). Nutritional Factors May Modify the Toxic Action of Methyl Mercury in Fish-Eating Populations. *Journal of Nutrition*, 133, 1539S-1543S.
- DeSombre, E. R. (2005). Understanding United States unilateralism: Domestic sources of U.S. international environmental policy. In R.S. Axelrod, D. L. Downie, & N. J. Vig (Eds.), *The global environment: Institutions, law, and policy* (2nd ed., pp. 181-199). Washington, D.C.: CQ Press.
- Easterly, T. W. (2006). Indiana power plant mercury rulemaking recommendation. Indiana Department of Environmental Management. Retrieved 11-10-2007 from, <http://www.in.gov/idem/rules/archives/packets/air/2006/oct/index.html>
- EPA (2002). An evaluation of the south coast air quality management district's regional clean air incentives market-Lessons in environmental markets and innovations. EPA. Retrieved 11-12-2007 from, <http://www.epa.gov/region09/air/reclaim/report.pdf>
- EPA (2006a). Clean air mercury rule: Basic information. EPA. Retrieved 1-7-2007 from, <http://www.epa.gov/air/mercuryrule/basic.htm>
- EPA (2006b). Discussion paper: CAMR market update. EPA. Retrieved 11-9-2007 from, <http://www.epa.gov/airmarkets/progsregs/camr/docs/CAMRMarketDevelopment.pdf>
- EPA (2006). EPA's roadmap for mercury (Rep. No. EPA-HQ-OPPT-2005-0013).
- EPA (2006c). Mercury emissions: The global context. EPA. Retrieved 11-10-2007 from, http://www.epa.gov/mercury/control_emissions/global.htm
- EPA (2006d). Mercury: Controlling power plant emissions: Decision process and chronology. EPA. Retrieved 11-10-2006 from, http://www.epa.gov/mercury/control_emissions/decision.htm#Chronology
- EPA (2006e). Mercury: Human exposure. EPA. Retrieved 11-13-2006 from, <http://www.epa.gov/mercury/exposure.htm>
- EPA (2006f). US Environmental Protection Agency: TRI Explorer. EPA. Retrieved 11-13-2007 from, <http://www.epa.gov/triexplorer/>
- EPA (2007a). CAMR frequent questions. EPA. Retrieved 11-14-2007 from, <http://www.epa.gov/airmarkets/progsregs/camr/faq-camr.html>
- EPA (2007b). Controlling power plant emissions: Overview. EPA. Retrieved 11-13-2007 from, http://www.epa.gov/mercury/control_emissions/index.htm
- EPPC, CHFS, & Commerce Cabinet (2006). Mercury task force report to the Environmental Quality Commission. EPPC. Retrieved 11-7-2007 from, <http://www.eppc.ky.gov/NR/rdonlyres/08F5199C-8AFB-425A-AE03-79C69145D756/0/MercuryReport.pdf>
- EQC (2006). Environmental Quality Commission: About the agency. EQC. Retrieved 1-7-2007 from, <http://www.eqc.ky.gov/>
- Harada, M., Akagi, H., Tsuda, T., Kizaki, T., & Ohno, H. (1999). Methylmercury level in umbilical cords from patients with congenital Minamata disease. *The Science of The Total Environment*, 234, 59-62.
- Kentucky Legislative Research Committee (2007). Kentucky Administrative Regulations: Title 401: Natural Resources and Environmental Protection Cabinet: Department for Environmental Protection. KAR. Retrieved 11-8-2007 from, <http://www.lrc.ky.gov/KAR/TITLE401.HTM>
- Legislative Services Agency. (6-27-2007). Fiscal impact statement. Rule #05-116. 11-10-2007. Ref Type: Bill/Resolution
- Lindberg, S., Bullock, R., Ebinghaus, R., Engstrom, D., Feng, X., Fitzgerald, W. et al. (2007). A synthesis of progress and uncertainties in attributing the sources of mercury in deposition. *Ambio*, 36, 19-32.
- Ormsbee, L., Bennett, B., Revlett, G., Wallace, P., Zick, E., & Knoth, L. (2004). Mercury in Kentucky: A public dialogue of issues and needs, based on the findings of the May 17, 2004 EQC public meeting.
- ORSANCO (2003). Strategic plan for the Ohio River Valley Water Sanitation Commission. ORSANCO. Retrieved 11-13-2007 from, <http://www.orsanco.org/orsa/Docs/Strategic%20Plan/StratPlan2003.pdf>
- Partnership for Healthcare Information (1998). Asthma in Vanderburgh County. University of Southern Indiana, College of Nursing and Health Professionals. Retrieved 10-22-2007 from, <http://health.usi.edu/commhlth/asthma/asthma.htm>



- Sands, P. & Peel, J. (2005). Environmental protection in the twenty-first century. In R.S.Axelrod, D. L. Downie, & N. J. Vig (Eds.), *The global environment: Institutions, law, and policy* (2nd ed., pp. 43-63). Washington, D.C.: CQ Press.
- Shore, M. (2003). *Out of control and close to home: Mercury pollution from power plants* Environmental Defense.
- Tietenberg, T. H. (2006). *Emissions trading: Principles and practice*. (2 ed.) Washington, D.C.: Resources for the Future.
- Trasande, L., Schechter, C. B., Haynes, K. A., & Landrigan, P. J. (2006). Applying cost analyses to drive policy that protects children: Mercury as a case study. *Ann.of the N.Y.Acad.Sci.*, 1076, 911-923.
- Valley Watch (2006). About Valley Watch. Valley Watch. Retrieved 10-30-2007 from, http://valleywatch.net/index.asp?id_nav=1
- Volz, C., Liu, Y., Sussman, N., Brady, S., Caruso, P., Green, T. et al. (2007). Mercury, arsenic and selenium in channel catfish from the Allegheny, Monogahela and Ohio rivers near Pittsburgh, PA: Implications for metallotoxin source identification and fish consumption by local anglers. In *Policy, Politics and Public Health Abstract* retrieved from http://apha.confex.com/apha/135am/techprogram/paper_157770.htm
- Weisenfluh, G. A., Cobb, J. C., Ferm, J. C., & Ruthven, C. L. (1996). Kentucky's coal industry: Historical trends and future opportunities. In M.T.Childress, B. M. Sebastian, P. Schirmer, & M. Smith-Mello (Eds.), *Exploring the frontier of the future: How Kentucky will live, learn and work* (pp. 145-154). Frankfort, KY: The Kentucky Long-Term Policy Research Center.
- Wu, Y., Wang, S., Streets, D. G., Hao, J., Chan, M., & Jiang, J. (2006). Trends in anthropogenic mercury emissions in China from 1995 to 2003. *Environ.Sci.Technol.*, 40, 5312-5318.

Addendum:

On February 8, 2008 the United States Court of Appeals for the District of Columbia vacated two final rules promulgated by the EPA (Federal District Court of Appeals for the District of Columbia, 2008). The first was the delisting of coal-fired electric utilities from Section 112 of the CAA for regulation of mercury as a HAP, and the second was the performance standards for new coal-fired electric utilities under Section 111 of the CAA. The delisting was found unlawful because under Section 112(c)(9) the EPA must show specific findings in order to delist a source. The EPA delisted coal-fired electric utilities without making any specific findings. Because the removal from Section 112 was unlawful, regulation of new and old sources under Section 111 is prohibited, effectively invalidating the cap and trade regulatory approach of the CAMR.

Reference

Federal District Court of Appeals for the District of Columbia (2008). *New Jersey et al v. EPA*. Federal District Court of Appeals for the District of Columbia, from <http://pacer.cadc.uscourts.gov/docs/common/opinions/200802/05-1097a.pdf>



Physical Activity and Classroom Behavior

Jeanne M. Cundiff & Rachel Knecht
University of Louisville

Abstract

America's public school systems are currently battling health and obesity issues, which may be partially addressed by increased physical activity. Different states have looked at various avenues for change such as cafeteria offerings, physical education (PE) classes, and the removal of vending machines. Kentucky's legislature has recently enacted an option for addressing physical activity during the school day that corresponds with the CDC's recommendation of moderate rates of physical activity for all ages. Not only has physical activity been found to help control weight, it helps children become more focused and results in fewer behavioral problems during the school day (Evans, 1981).

The current study examined whether there was a relationship between participation in weekly physical activity by third graders and classroom referrals for behavioral problems. Behavior was also assessed by teachers using a rating scale. The findings suggest that increased physical activity related to fewer referrals for behavior problems in the classroom and teachers' ratings of classroom behavior were more positive.

BACKGROUND

Does Physical Activity During School Relate to Classroom Behavior in Elementary School Children?

To examine the effects of physical activity on academic success, a range of variables were considered. Past research has investigated a number of these variables such as attention, engagement, behavioral referrals, and academic achievement. Researchers have also looked at variables such as achievement in general, and factors that may mitigate or increase student achievement and motivation.

Classroom behavior and school success

Classroom behavior and achievement outcomes have been shown to be strongly related (Finn, Pannozzo, & Voelkl, 1995; Truesdell & Abramson, 1992; Rock, 2005). Akey (2006) found that students' positive attitudes and behavior play a critical role in academic improvement, specifically in high-risk populations. Additionally, Pannozzo et al. (1995) found academic achievement to be strongly related to student attentiveness and behavior in the classroom. Truesdell and Abramson (1992) examined the relationship between classroom behaviors and end of the year grades with a special focus on children with disabilities. Their study reported that writing and reading scores were higher for those students who had fewer overall behavior problems during class. Similarly, Rock (2005) examined students' engaged academic behavior in classrooms and found that high-achieving students were academically engaged 75% of the time, compared to 51% for low-achieving students. The longer students remain disengaged from tasks, the more likely it is their academic performance will suffer.

Numerous studies examine the relationship between attention and behavior in the classroom (Wineberg, 1988; Harris, Friedlander, Saddler, Frizzelle, & Graham, 2005; Miller, Koplewicz & Klein, 1997). Harris et al. (2005) observed attention and performance monitoring in on-task behavior and spelling in elementary students with attention-deficit/hyperactivity disorder (ADHD) in relation to classroom behaviors. Both self-monitoring of attention and self-monitoring of performance had positive effects on students' on-task and spelling behaviors and, when on-task behaviors increased, spelling scores increased as well.



Physical activity and classroom behavior

Engagement in physical activity during the school day has been shown to relate to more “on task” behaviors in fifth-grade children with no diagnosable attention problems (Wineberg, 1988). Even small amounts of physical activity have been shown to be positively related to desired classroom behaviors such as motivation and attention (Tkachuk & Martin, 1999).

Physical activity has been shown to not only alleviate many kinds of psychological illnesses, but also to augment general feelings of well-being (Tkachuk & Martin, 1999). Many studies focusing on children’s referrals for behavioral problems have linked referrals to a lack of self-regulation in the form of impulsive behavior and a lack of self-control. Literature that supports the idea that physical activity may lessen problems of impulsive behavior in the classroom comes in large part from the study of children with ADHD who show high rates of impulsive behavior. Baker (2005) reported that fifth grade children with ADHD who were given activity breaks, demonstrated improvement in achievement and engagement and fewer disruptive behaviors.

In a study of emotionally handicapped adolescents, Evans (1981) examined how exercise related to students’ behavior using a number of scales related to behavioral referrals. The investigator measured the number of “talk outs” occurring per class session, teacher ratings, dean’s reports, and the number of completed written assignments. Results showed a significant decrease in negative behaviors for those students in the exercise condition versus the students who did not participate in the exercise condition (Evans, 1981).

Studies suggest that exercise enhances perceived competence and self-esteem, specifically in elementary-aged students (Xiang, 2004; Sachs & Buffone, 1997; Parish & Treasure, 2003); and these factors are related, in turn, to positive classroom behaviors and positive school outcomes. A study by Kirkcaldy, Shephard and Siefen (2002) studied the regular practice of endurance exercise and found a relationship to a more favorable self-image. As little as ten minutes of physical activity per day is sufficient to obtain the mood-elevating effects of exercise as well as improvements in feelings of physical and psychological well-being (Doucette, 2004). Improvements in physical fitness result in more positive social interactions, which leads to improvements in an individual’s self-image and academic achievement outcomes (Kirkcaldy, Shephard & Siefen, 2002).

A recent study by Xiang, Solomon, and McBride (2006) explored teachers’ and students’ conceptions of ability in physical education. Fourth grade students were asked in the fall and later in the spring of the same school year to indicate their perceptions of their abilities and physical activity. Results showed that physical activity was related to increased motivation, toward not only achievement in physical education, but also toward their own educational, achievement goals, and overall motivation in school. Data also suggests that physical activity is associated with mastery behaviors and positive motivational responses such as per-

sistence and effort in elementary school students (Xiang, Bruene, & McBride, 2004). Even small amounts of physical activity are positively related to desired classroom behaviors such as motivation and attention (Tkachuk & Martin, 1999).

There is clear support for the idea that physical activity may have a positive influence on behavior, which, in turn, has a positive impact on academic achievement (Way, 2003).

In Kentucky, Statute KRS 156.160, formerly known as Bill 172, permits physical activity to be considered as part of the instructional day; however, it may not exceed thirty minutes per day or one hundred and fifty minutes per week. The hypothesis of this study supports the broad policy implications for requiring physical activity in schools. The evidence presented here suggests the importance of physical activity in the classroom because it positively affects student health, behavior and achievement. The purpose of the current pilot study is to examine the relationship between physical activity and classroom behavior of children from low-income families in selected elementary schools in Jefferson County, Kentucky.

METHODS

Participants

The target population in this study was children in 3rd grade classrooms from schools designated as high risk for low academic achievement based on economic factors. Information about these children was obtained from teacher reports and from school records. Participants were teachers of 3rd grade elementary students from eighteen classrooms. These classrooms were selected from a list of high-risk schools with no provision for physical education classes.

Procedure

Participation involved completing a short questionnaire to provide an overall classroom behavior rating and a tally of the behavioral referrals from the 2006-2007 school year.

Behavioral Assessments

A questionnaire was developed to assess overall impulsive behavior in the classroom. The first part of this assessment was an adaptation of the hyperactivity scale from the BASC (Behavioral Assessment System for Children). The second part of this assessment was a general teacher rating of overall classroom engagement and the total number of referrals over the past school year. Information concerning the amount of time spent in various types of activities, total amount of time doing physical activities, where the activity occurs (inside vs. outside), and time of day was collected.

Data on behavior was gathered in the form of disciplinary referrals for students. Of a sample of eighty-eight elementary schools (Grades K-5) with a total enrollment of 41,768 students, 14,213 in-school behavioral referrals were identified.



Statistical Analyses

The effects of physical activity on behavior were examined using hierarchical multiple regression analyses. The teachers' overall rating of classroom behavior was compared to the total minutes of engagement in physical activity per week by the class. Also investigated was the rate of referral for behavior problems and the total number of minutes of engagement in physical activity per week by the class.

Additional analyses examined the effects of participation in recess on behavior. Specifically, a t-test was used to compare the rate of behavioral referrals for classes with and without recess. An additional t-test compared teacher ratings of behavior on the BASC hyperactivity scale between classes with and without recess. Finally, the relationship between teacher ratings of behavior and number of classroom behavioral referrals was investigated using a hierarchical multiple regression analysis. All analyses were performed using SPSS (statistical software package).

RESULTS

Overview

Data on physical activity and behavioral referrals were collected for 14 elementary school teachers representing an average instructional class size of 26 students. Physical activity and behavioral referrals were measured using teacher self-report in the form of a questionnaire.

The average number of minutes per week spent engaged in physical activity was 132 minutes with a standard deviation of 120.25 minutes. There was no clear difference in the total amount of exercise between classrooms that participated in recess and those classrooms that did not (see Table 1). The distribution of referrals for the fourteen-classroom cohort, showed a mean of 2.71 with a standard deviation of 1.68 (see Figure 1). Additionally, the mean and standard deviation for the distribution of the 14 teachers' overall rating of classroom behavior was 22.57 (S.D. = 4.35; see Figure 2).

There was a trend toward more negative behaviors (as rated by the teachers) as physical activity decreased. Teachers who reported incorporating less physical activity into the school day also reported that each negative behavior (from the BASC hyperactivity scale) occurred more often (See Table 2).

Findings

Teachers' composite ratings of student behavior on the BASC scale were significantly correlated with the total amount of physical activity in the classroom, ($p = .038$, $r^2 = .24$; see Figure 3). The relationship between the number of minutes spent engaged in physical activity and behavioral referrals was also significant ($p = .031$, $r^2 = .26$; see Figure 4).

Teacher ID	Physical Activity Total	Recess
6	450	Y
9	335	Y
8	165	Y
4	145	N
14	120	N
5	110	Y
2	110	Y
7	100	Y
1	95	N
10	65	Y
3	60	N
11	30	N
12	30	N
13	30	N

Table 1. Total amount of physical activity and participation during recess.

Histogram

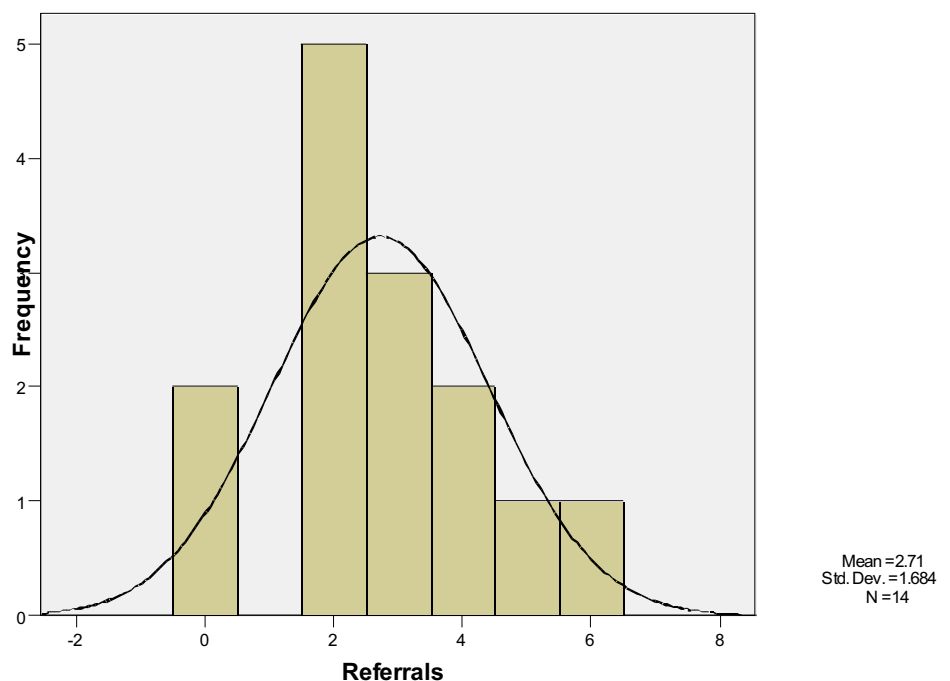

Figure 1. Distribution of Referrals



Additional Analyses

Differences were also found in the number of referrals for classes with and without recess ($p = .05$). Specifically, classes without recess ($M = 3.57$, $S.D. = 1.51$) averaged approximately twice as many referrals as classes with recess ($M = 1.86$, $S.D. = 1.46$).

Conversely, no significant difference was found between classes that participated in recess and classes that did not participate in recess in relation to the overall teacher rating of behavior ($p = .093$). Our two measures of behavior (number of behavioral referrals and teacher rating on the BASC hyperactivity scale) were correlated ($p = .043$, $r^2 = .23$; see Figure 5).

Discussion

This study hypothesized that more participation in weekly physical activity during the school day, aside from participation in physical education classes, would lead to fewer referrals for behavioral problems and better overall classroom behavior among elementary school students. As hypothesized, it was found that teacher ratings of behavior and the number of minutes spent engaged in physical activity were related, as were physical activity and behavioral referrals. Additionally, the rate of behavioral referrals for those classrooms that participated in recess was significantly lower than for those classrooms that did not participate. Taken together, these findings support the hypothesis that physical activity during the school day may lead to better overall behavior in the classroom.

Engagement in physical activity does not necessarily mean that children physically left the classroom. Although teachers were asked how many minutes per week they spent in different activities (i.e. sit ups, running outside, walking inside, activity video, etc.), it was the sum of the minutes in all of these activities that was analyzed. Therefore, this association of increased physical activity and positive classroom achievement implications is not dependent on access to a park or a playground. In fact, it seems that teachers do not even need to leave their classrooms in order to provide time for their students to engage in physical activity.

Recess, Physical Activity, & Classroom Behavior

The inclusion of recess during the academic day was analyzed. Many schools have phased out, in addition to physical education, recess in support of increased instructional time. However, it seems that students are better able to self regulate when they are allowed some physical activity during the course of the day. In particular, overall classroom referrals were reduced by half when

BASC Sum

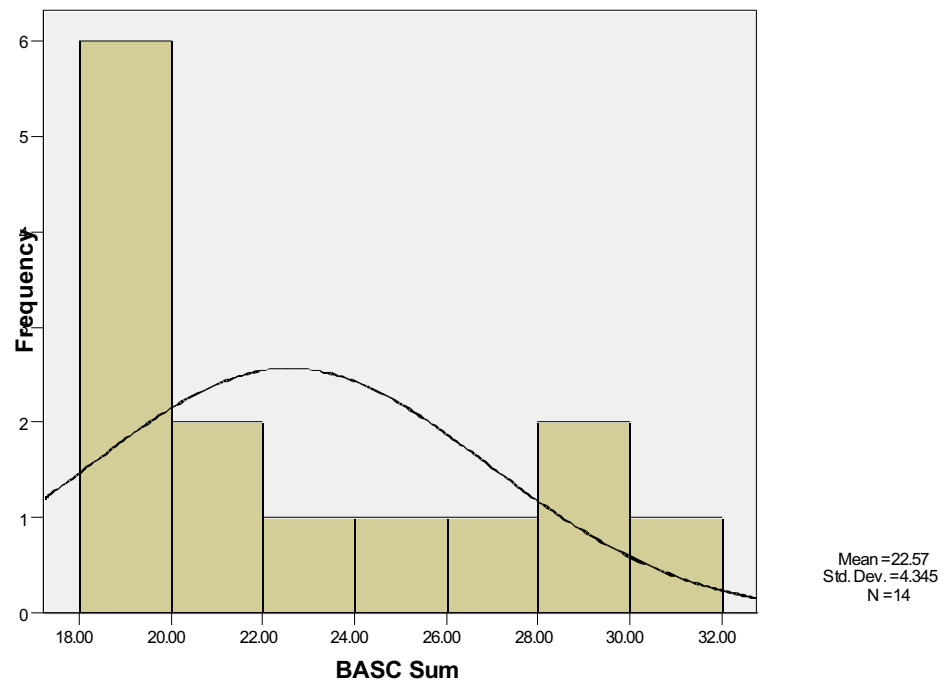

Figure 2. Distribution of BASC composite scores.

students participated in recess. The time of day recess and/or physical activity occurred did not seem to affect the students' overall behavior. Thus, the simple inclusion of physical activity during the day seems to produce the desired behavioral effects independent of when this activity takes place. According to teacher ratings, the two behaviors most affected by the presence of recess were students' increased ability to wait to take turns ($p = .01$), and abstaining from hurrying ($p = .049$).

A significant difference was also found in the total amount of physical activity between two particular groups: those students who participated in recess and those who did not ($p = .023$). Suggesting a compounding effect. It seems that children who had recess were also more likely to have a teacher who incorporated physical activity into the class day. Children who were getting more physical activity during the day may have been more likely to see a decrease in negative behavior because they were also more likely to have recess. When we compared the behavioral data to the number of minutes of physical activity (not including recess), we may also be seeing the joint effect of recess.

General Engagement

Also assessed by the teachers were engagement trends of the students at different times during the day. What was observed was that engagement continues downward over the course of the day independent of whether students exercise midmorning, midday, or in the afternoon. Thus, physical activity does not seem to affect the pervasive trend of decreasing engagement throughout the school day.



Physical Activity Total	Bother others when they are working	Callout in class	Cannot wait to take turn	Scream	Seek attention while doing school work	Interrupt others when they are speaking	Hurry through assignments	Make Loud noises when playing	Tap foot or pencil	Talk too loudly
450	2	2	2	1	2	2	2	2	2	2
335	2	2	2	1	2	2	2	1	2	2
165	2	2	2	1	2	2	2	2	2	2
145	2	2	3	2	2	3	3	2	3	3
120	2	2	2	1	2	2	3	2	3	2
110	2	3	2	2	2	2	2	3	2	2
110	2	2	2	1	2	2	2	2	2	2
100	3	4	2	2	2	4	4	4	3	3
95	2	3	2	2	2	2	2	2	2	2
65	2	2	2	1	2	2	2	2	2	2
60	2	2	2	1	2	1	3	2	2	2
30	3	2	4	2	3	3	3	4	2	2
30	2	2	4	2	3	2	3	4	3	3
30	3	2	4	2	2	2	3	4	2	3

Table 2. Physical activity totals and individual ratings on the BASC scale by teacher.

Implications

The assumption that more hours of teaching leads to better test scores is mitigated by the possibility that physical activity leads to better behavior, which in turn, leads to better achievement. Better classroom behavior has been linked to higher achievement (Way, 2003; Finn, Pannozzo, & Voelkl, 1995; Truesdell & Abramson, 1992; Rock, 2005; Akey, 2006), thus, if physical activity is correlated with better classroom behavior, it is necessarily tied to achievement. The loss of physical education classes in public schools coupled with rising obesity rates has led to a push for increased awareness of children's physical fitness. In fact, "the percent of school-age children 6 - 11 who are overweight more than doubled between the late 1970s and 2000, rising from 6.5% to 15.3%." (Walk on Ohio County, 2007).

Legislators are leaning toward the introduction of school wellness policies to increase student health. A push for the exclusion of vending machines and the inclusion of healthier foods in the cafeteria are among the first steps. New York has mandated 120 minutes of physical education per week for schoolchildren. The schools that offered at least the mandated 120 minutes of physical education per week had significantly lower rates of student obesity than schools that did not provide the required physical education, even after adjusting for differences in socioeconomic status.

A recent article quoted Wendy Wolfe, Cornell University's Nutritional Sciences expert, speaking about the Childhood Obesity Prevention Act, as saying, "Recent research suggests a correlation not only between physical activity and obesity but

also between physical activity in children and improved learning" (Anonymous, 2003). Several studies indicate that academic achievement improves even when increased time for physical education reduces the number of hours spent in direct instruction of material (Somerset, 2007; Siegel, 2006; Sallis, McKenzie, Kolody, Lewis et al., 1999). The Centers for Disease Control and Prevention is recommending daily physical education on a national basis based on research showing the obvious benefits.

Limitations

A limitation to the statistical power of this study is the population sample size (n= 14). Also, teachers may have included recess when reporting total number of minutes engaged in physical activity. Similarly, teachers were asked, specifically, for the number of minutes per week spent in each activity; however, a few teachers may have reported the total number of *daily* minutes in each activity as opposed to a weekly total. Further, although part of the questionnaire was the BASC scale for hyperactivity, there is a problem in that teachers' responses are highly individualized to both the individual questionnaire factors (i.e. bothers others when working, talks too loudly, etc.) and response (i.e. never, sometimes, often, almost always).

Clinical Implications

The results of this study will contribute to the literature on physical activity as it relates to classroom behavior and academic achievement. Although physical activity and academic achievement have been linked, this study suggests that behavior may be an intervening factor. If physical activity does decrease negative



behavior in the classroom then there is good reason for teachers to ensure that their students get some sort of physical activity in their daily routine. Further, this routine physical activity is in line with the current national childhood obesity initiative, as children who are more strongly encouraged to be physically active are also less likely to be overweight. Also, children who are in good health are less likely to suffer from depression, low self-esteem and other negative mental consequences of obesity and poor physical health.

References

- Akey, T.M. (2006). School context, student attitudes and behavior, and academic achievement: An exploratory analysis. MDRC online publication.
- Anonymous. (2003). Preventing childhood obesity at school, at home, and in the community. *Human Ecology*, 31, 2, 23.
- Baker, Teresa C. (2005). The use of mini-exercise breaks in the classroom management of ADHD-type behaviors. Ph.D. dissertation, Capella University, United States — Minnesota.
- California Department of Education. (2003). California physical fitness testing: Report to the government and legislature. Retrieved 2007 April 4 from www.cde.ca.gov/ta/tg/pf/documents/rptgov2002.pdf.
- Doucette, P.A. (2004). Walk and talk: An intervention for behaviorally challenged youths. *Adolescence*, 39, 373-388.
- Evans, William H. (1981). The effects of exercise on selected classroom behaviors of emotionally handicapped adolescents. Ph.D. dissertation, University of Florida, United States — Florida.
- Finn, J.D., Pannozzo, G.M., & Voelkl, K.E. (1995). Disruptive and inattentive- withdrawn behavior and achievement among fourth graders. *The Elementary School Journal*, 95, 5, 421- 434.
- Harris, K.R, Friedlander, B.D., Saddler, B., Frizzelle, R., & Graham, S. (2005). Self-monitoring of attention versus self-monitoring of academic performance: Effects among students with adhd in the general education classroom. *Journal of Special Education*, 39(3), 145-156.
- Kirkcaldy, B.D, Shephard, R.J. & Siefen, R.G. (2002). The relationship between physical activity and self-image and problem behavior among adolescents. *Social Psychiatry and Psychiatric Epidemiology*, 37, 11, 544-
- Miller, L.S., Koplewicz, H.S., & Klein, R.G. (1997). Teacher ratings of hyperactivity, inattention, and conduct problems in preschoolers. *Journal of Abnormal Child Psychology*, 25, 2, 113- 120.
- Parish, Loraine E. & Treasure, Darren C. (2003). Physical activity and situational motivation in physical education: Influence of the motivational climate and perceived ability. *Research Quarterly for Exercise and Sport*, 74, 2, 173-182.
- Rock, M.L. (2005). Use of strategic self-monitoring to enhance academic engagement, productivity, and accuracy of students with and without exceptionalities. *Journal of Positive Behavior Interventions*, 7(1), 3-17.
- Sachs M. L. & Buffone, G. W. (1997). *Running as Therapy: An integrated approach*. Lincoln, NE: University of Nebraska Press.
- Sallis, James F., McKenzie, Thomas L., Kolody, Bohdan, Lewis, Michael, et al. (1999). Effects of health-related physical education on academic achievement: Project SPARK. *Research Quarterly for Exercise and Sport*, 70(2), 127-134.
- Siegel, Donald. (2006). Physical Fitness and Academic Achievement. *Journal of Physical Education, Recreation & Dance*, 77(2), 9.
- Somerset, Beth Sigman. (2007). Relating physical education and activity levels to academic achievement in children. *Journal of Physical Education, Recreation & Dance*, 78(1), 10.
- Tkachuk, Gregg A. & Martin, Gary L. 1999. Exercise therapy for patients with psychiatric disorders: Research and clinical implications. *Professional Psychology: Research and Practice*, 30(3), 275-283.
- Truesdell, L.A., & Abramson, T. (1992). Academic behavior and grades of mainstreamed students with mild disabilities. *Exceptional Children*, 58(5), 393-400.
- Walk on Ohio County. Statistics for Childhood Obesity. (2006). Retrieved 4 April 2007 from www.ohio.k12.ky.us/Walk/statistics.htm.
- Way, S.M. (2003). For their own good? The effects of school discipline and disorder on student behavior and academic achievement. Ed.D. dissertation, The University of Arizona, United States—Arizona.
- Wineberg, Mark Douglas (1988) The relationship between physical fitness development and on-task behavior in the fifth grade classroom. Ed.D. dissertation, University of Cincinnati, United States — Ohio.
- Xiang, P., Bruene, A., & McBride, R.E. (2004). Using achievement goal theory to assess an elementary physical education running program. *Journal of School Health*, 6, 220-225.
- Xiang, P., Solomon, M.A., & McBride, R.E. (2006). Teachers' and students' conceptions of ability in elementary physical education. *Research Quarterly for Exercise and Sport*, 77, 2-10.

Environmental Education and Academic Achievement in Elementary School Children

James M. Edlin
University of Louisville

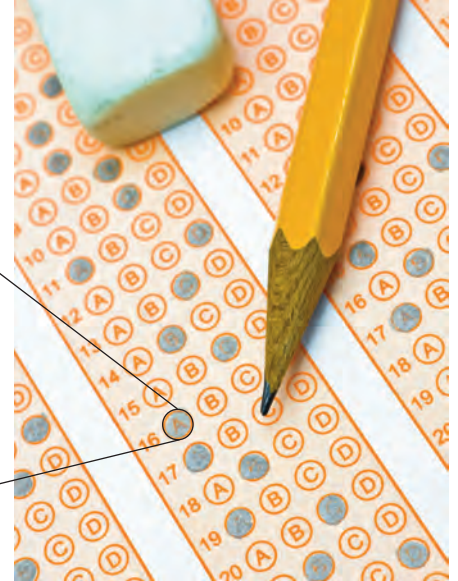

Abstract

This pilot study compared achievement test scores on the Commonwealth Accountability Testing System (CATS) based on participation in a program that uses the environment as an integrated context for learning (EIC). A significant difference was found for both reading and science scores in groups who visited the EIC site 4 times and groups that did not participate. There was also a non-significant increase in average test scores per number of visits.

Environmental Education and Academic Achievement in Elementary School Children

Previous studies suggest that using the environment as an integrated context for learning (EIC) has the potential to positively impact achievement scores. One group, The State Education & Environment Roundtable (SEER) has produced the guidelines for the EIC method and reported that programs that use this method can increase achievement scores (Lieberman & Hoody, 1998). The EIC method is comprised of somewhat generalized guidelines and two programs that qualify as EIC may have extremely different curricula. What all of these programs have in common is that they attempt to get the child out of the classroom and into a naturalistic setting where a subject is taught using the environment as a tool. The naturalistic setting may involve everything from a park, greenhouse, or even a field near the school. EIC programs reinforce classroom teaching by incorporating information from the students' curriculum and attempt to improve students' attitudes about learning. "Environmental education programs teach students that they can make important contributions to the their family and community" (Smith, 2002).

The North American Association for Environmental Education reported that EIC programs improve grades, attendance, and increase the engagement of both students and teachers (Glenn, 2000). While this increase in engagement is most likely responsible for the improvement in attendance, both of these factors have a synergistic effect on grades. In fact, environmental education programs have a variety of factors that are commonly associated with higher achievement. These programs are centered on demonstrations and hands-on experience while many also include discussion groups and chances for students to teach other students. These factors are thought to improve achievement by

increasing the average retention rate of information. Achievement is also increased due to the fact that students are more motivated to learn when material is presented in an interesting way. Prior studies have found that academic motivation has substantially developed by age nine and this attribute grows more stable over time (Gottfried, Fleming, & Gottfried, 2001). Therefore, EIC programs also assist in achievement by improving motivation to learn at an early age.

Despite the success of some studies in confirming the potential of EIC programs, other studies produce conflicting results. For example, in one study using eight comparisons from California schools, SEER found schools participating in EIC programs significantly outperformed traditional schools in four of these comparisons, and one comparison yielded results in favor of the traditional school (Lieberman, Hoody, & Lieberman, 2000). Because of this variation in the success of EIC programs, individual programs must be evaluated in order to determine the effectiveness of the curriculum in relation to the school system. Research is needed to identify the specific features of these programs that make them successful and the processes by which these features improve student outcomes. EIC programs contain direct tangible benefits such as applied learning or interdisciplinary integration of material, which enhances learning. However, inclusion of these properties does not predict the success of the program and it has been suggested that benefits may result from the effects of indirect factors such as increasing motivation or engagement. We must also consider "students as active processors, and critical consumers, of learning situations such as environmental lessons" (Rickinson, 2001, p. 284). We must gain a better understanding of what aspects of environmental education provide these intangible benefits so that these factors can be left intact while still giving us the flexibility to modify programs to suit the needs of educators and students.

The current study analyzed the relationship between participation in an environmental education program and student achievement using the Commonwealth Accountability Testing System (CATS). The relation of number of visits to the environmental education site and reading and science scores were assessed. With the advent of programs such as *No Child Left Behind* and the increasing demand to improve the quality of our schools, it is important to discover programs that improve achievement and determine why these programs are effective.



METHOD

Subjects

During the 2005-2006 school year, fourth grade classrooms at five schools participated in the observed environmental education program. Five comparison schools were chosen based on the total number of students at the school, the number of students per teacher in the classroom, and the percentage of students from low-income families. In this way, we can ensure that students in the target schools are selected from environments similar to the comparison schools. While most schools within the experimental group had a similar comparison school, School 3 stands out because it includes all grades from kindergarten through high school. Schools that were close in comparison in the number of students from low-income families were different in structure from school 3. Therefore the comparison school was, instead, chosen based on similarity of policies and extracurricular options.

Measurement

Student achievement for the 2004-2005 school year was measured using CATS scores. CATS is a standardized achievement test in Kentucky that measures reading and science ability at the fourth grade level using a combination of multiple choice and open response questions. Teachers in the Jefferson County Public School (JCPS) System administer this test yearly as part of the normal curriculum.

Design

The directors of the EIC program provided us with a list of classrooms that visited the environmental education site and the dates on which they visited during the 2005-2006 school year. We then collected CATS scores for students in the ten classrooms in the Jefferson County school system for the same year. JCPS provided us with these scores sorted by classroom and devoid of identifying information. This noninvasive method provided us with sufficient data to determine the significance of the program without risk to students. These procedures were approved by the Institutional Review Boards at the University of Louisville and JCPS.

Results

To determine if there was a relationship between participation in the EIC program and CATS scores, we performed an analysis of variance and found significant effects for both reading [$F(3,651) = 3.002, p = .030$] and science [$F(3,651) = 4.192, p = .006$]. There was a general increase in the average CATS science scores per visit as shown in Figure 1, yet the effect was not significant until the students made four visits [$p = .006$]. Figure 2 illustrates a positive increase in reading scores based on the number of visits that also reached significance after four visits [$p = .018$]. The results of two schools, a participating school and a

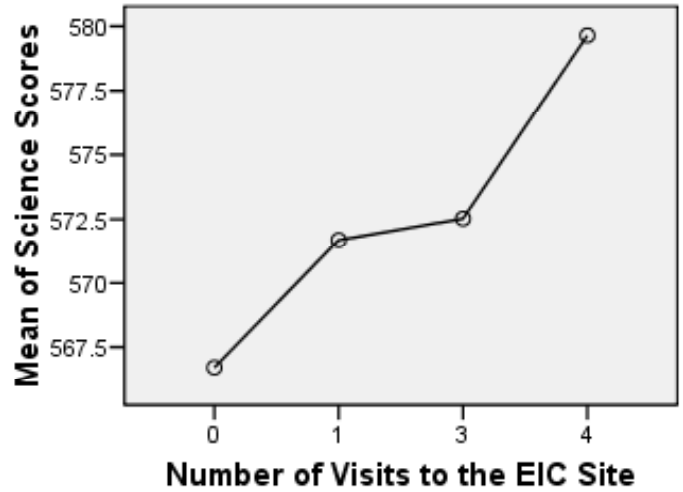

Figure 1. Comparison of CATS Science scores based on the number of trips to the environmental education site (Blackacre).

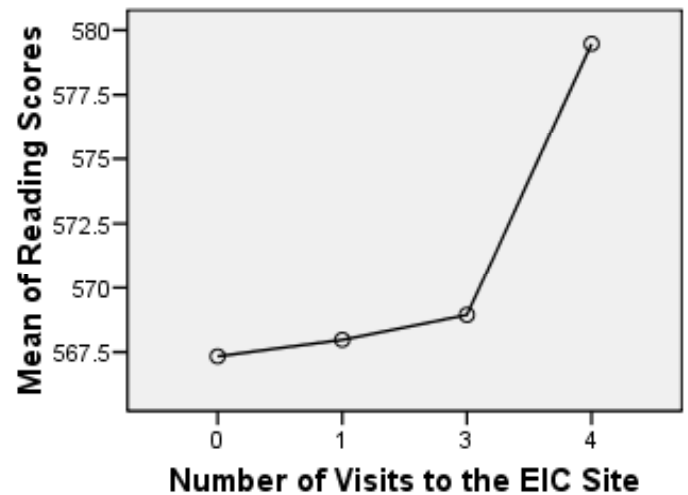

Figure 2. Comparison of CATS Reading scores based on the number of trips to the environmental education site (Blackacre).

comparison school, were removed from the results because they both performed significantly lower than other schools. When the data from these schools was included there were no significant results for either science or reading. We felt confident in removing these data from the analyses because they fell outside the confidence intervals of the other schools and it was concluded that the students' scores in those schools were being affected by other variables, which were beyond the scope of this study.



Discussion

This study tested the hypothesis that there is a relationship between participation in an environmental education program and student achievement. By environmental education, we mean programs that use the environment as an integrated context for learning. A local program was chosen and the number of trips a student made to the location was compared to the students CATS scores for science and reading. Our finding suggests that students who made four trips to the program outperformed students who made fewer trips or did not participate. These results are consistent with other findings (Lieberman & Hoody, 1998; Lieberman et al., 2000) and suggest that using the environment as an integrated context for learning can improve achievement scores. These results also imply that participation in an environmental education program may have a cumulative effect since fewer than four visits had relatively little effect.

While this pilot study did not determine how environmental education affected achievement, the assumption that a relationship does exist between environmental education programs and academic achievement was confirmed in this small sample. This study was limited in that it had no controls for extraneous variables such as teacher performance or classroom curriculum, but was developed as an exploratory analysis to determine if a relationship existed between the two conditions. Therefore, this study can only confirm a relationship but gives us no information as to the factors of that relationship. We do not know if more visits would continue to improve achievement, or if there is a plateau of effect. There was also no control in place to account for individual differences between teaching style, other programs being used at the schools, and class engagement prior to participation in the program. Another important aspect of these effects that was not analyzed is the duration of the benefits of participation in the program.

The purpose of this preliminary study was to ensure that the program under review augmented achievement in order to justify using it as a basis for further research. Additional research using this program may prove successful in determining how EIC programs affect student achievement. One concept that needs to be explored is that this improvement may be the result of increasing student engagement or motivation to learn. Current literature suggests that academic achievement is positively correlated with a student's engagement (Fredricks, Blumenfeld, & Paris, 2004). Do EIC programs increase engagement and therefore achievement, or are more engaging teachers more likely to take advantage of these programs? In order to answer this question, a future study should be conducted using random assignment of classrooms to an environmental education program. It would also be informative to follow these classrooms throughout the year and take periodic assessments of engagement and achievement. These assessments can be compared based on participation in the EIC program to determine the extent of that programs role in achievement and engagement. This would allow researchers to determine if increased student engagement is the underlying EIC trait that is

improving academic performance, and the duration and extent of engagement increase..

Our findings raise some very important questions that must be answered in future research involving EIC programs. The results of these studies could assist when developing new educational programs or measuring the efficacy of programs already in place. They can also determine what current educational curricula lack in order to provide the proper tools for all students to succeed. If these tools are built around EIC programs, then we can increase the effectiveness of our educational programs, as well as engender a deeper respect for our environment in following generations.

Author's Note

I would like to thank Donna Griffin for collecting and providing the data from the EIC site, Marco Munoz for providing the CATS scores, and David Wicks, the Jefferson County Public School System, and the Gheens Academy for helping bring this project together.

James Edlin is a researcher and graduate teaching assistant at the University of Louisville.

References

- Fredricks, J. A., Blumenfeld, P. C., & Paris, A. H. (2004). School Engagement: Potential of the Concept, State of the Evidence. *Review of Educational Research*, 74(1), 59-109.
- Glenn, J. L. (2000). Environment-Based Education: Creating High Performance Schools and Students. Retrieved 9.October 2006, from <http://www.neetf.org/pubs/NEETF8400.pdf>
- Gottfried, A. E., Fleming, J. S., & Gottfried, A. W. (2001). Continuity of Academic Intrinsic Motivation from Childhood through Late Adolescence: A Longitudinal Study. *Journal of Educational Psychology*, 93(1), 3.
- Lieberman, G. A., & Hoody, L. L. (1998). Closing the Achievement Gap: Using the Environment as an Integrating Context for Learning. Results of a Nationwide Study (pp. 117): State Education and Environment Roundtable, 16486 Bernardo Center Drive, Suite 328, San Diego, CA 92128; Tel: 619-676-0272; Web site: <http://www.seer.org>.
- Lieberman, G. A., Hoody, L. L., & Lieberman, G. M. (2000). California Student Assessment Project: The effects of Environment-based Education on Student Achievement. Retrieved 9.October 2006, from <http://www.seer.org/pages/research/CSAP2000.pdf>
- Rickinson, M. (2001). Learners and Learning in Environmental Education: A Critical Review of the Evidence. *Environmental Education Research*, 7(3), 207.
- Smith, G. A. (2002). Going Local. *Educational Leadership*, 60(1), 30.



COMPARISON OF DAYLIGHTING DEVICES FOR USE IN JEFFERSON COUNTY PUBLIC SCHOOLS

Eric Biebighauser
Supervised by: Dr. M. Keith Sharp
Department of Mechanical Engineering
Speed Scientific School, University of Louisville

Abstract

Jefferson County Public Schools of Louisville, Kentucky wish to install daylighting devices in classrooms to compliment automatic light dimmers. Three devices were provided for investigation; a 24 inch light shelf, a 16 inch light shelf, and a LightLouver system (See Figures 1 and 2). Measurements were made using a digital light meter to gage the distribution and intensity of light in the classrooms. The same measurements were made in a control classroom with no daylighting device and the results for all tests tabulated.

The 16 inch protrusion light shelf was found to provide the most light to its classroom, however, it also had the greatest variation between its brightest and darkest areas. The control room was found to be the next best performer followed by the LightLouver system while variations in room design made the 24 inch light shelf difficult to compare with the other systems.

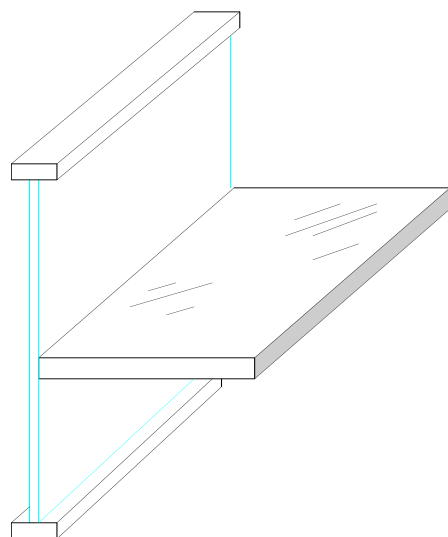

Figure 1. Schematic of Light Shelf.

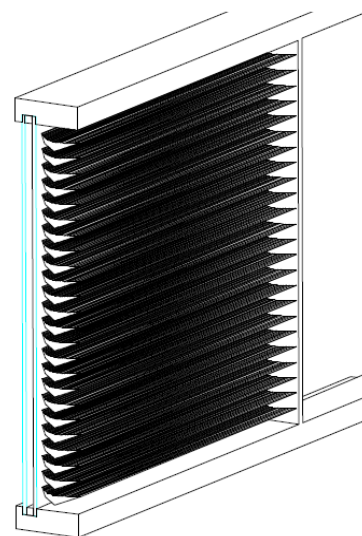

Figure 2. Schematic of LightLouver™ system.

Introduction

During the 2005/2006 school year, Kentucky spent \$120 million on electricity and fuel costs for their schools¹. This is more than what they spend on textbooks and computers combined². With an ideal application of daylighting to Kentucky's public schools the state could save up to \$42 million a year³. This is money that could be used to build about 28 new schools or help better equip students with computers and supplies.

In 2004, 35% of electric energy produced in the United States was consumed by commercial buildings⁴. Of this energy, 40 to 50% was consumed for lighting⁵. This amounts to about 660,000 million kWh of electricity used for lighting in commercial buildings alone, not including residential buildings or industrial ones. Residential buildings accounted for 36% of the energy used in 2004 with about 36% of that energy going into lighting⁶.

Buildings designed with daylighting in mind, using proper orientation, high ceilings, and open floor plans, can use about 70% less electricity for lighting. This can be considerable savings since the reduction in heat generated by operating incandescent or fluorescent bulbs is removed. Air conditioning costs can be reduced by about 10%⁶. Buildings not designed for daylighting, but being retrofitted with it, can achieve lighting cost reductions of 30 to 50%. Daylighting retrofits can quickly pay for themselves, often in less than a year.

In an academic setting, daylighting can enhance student's ability to learn significantly. The Heschong Mahone Group conducted a detailed study on behalf of Pacific Gas and Electric Company involving about 21,000 students in three school districts and found that the learning rates of students can increase 20% faster in math and 26% faster in reading⁷ versus those with the least amount of natural light. Other benefits including increased alertness and better behavior are also associated with daylighting.



Other benefits of widespread daylighting are a reduction in the production of greenhouse gases, since it lowers electricity use and a reduction in power shortages since daylighting is most effective during peak electrical demand hours. Daylighting is a practice that can be applied widely in order to reduce our reliance on foreign energy.

Methods

The devices being tested are the LightLouver system and two light shelf units. The light shelves are the same design however one has a 24 inch protrusion from the window while the other protrudes 16 inches from the window. These units were installed in classrooms with south western exposure. All four classrooms were identical in size. Rooms 202, 204, and 205 were identical in layout while room 203 was set up as a mirror image of the other classrooms.

The window faces 30 degrees west of south, giving no direct light in morning hours and extra direct light in the evenings. All rooms have grayish-white floor tiles which are kept waxed and thus are very reflective. All walls are semi-gloss white and cinder-block and all ceilings are drop type and white in color. One wall of each classroom is almost entirely covered with dark blue cubby holes for students to place their belongings in. Classroom lights are turned off for all measurements and the door to the room closed to block light from the hallway. Room dimensions are approximately 316 inches wide by 408 inches deep and the rooms have a ceiling height of 108 inches with flush mounted fluorescent lighting.

Room 202 is the control room with no daylighting device. This room is used as an auxiliary room for students and does not feature extensive decorations and generally had several tables and chairs spread throughout. The window blinds are kept fully open during testing since none of the other rooms being tested have blinds. The window edge is located 20 inches from the west wall.

Room 203 is fitted with a 24" protrusion light shelf. The light shelf is constructed from two inch square tubing used for screen door construction. This frame is rectangular in shape with three cross pieces extending perpendicular to the window in order to support the Mylar cover. The Mylar cover is stretched over the entire surface of the light shelf and is held in with a piece of rubber jammed into the gaps manufactured into the framework. This construction technique is the same as is used on screen doors only with Mylar instead of screen. This shelf is bracketed to the cinder blocks around the window with its top surface 23.5 inches from the top of the window. The shelf is 121 inches wide and spans the entire width of the window. This room is used as a full time classroom and has decorations on the walls but no floor treatments. The edge of the window is located 41 inches from the east wall.

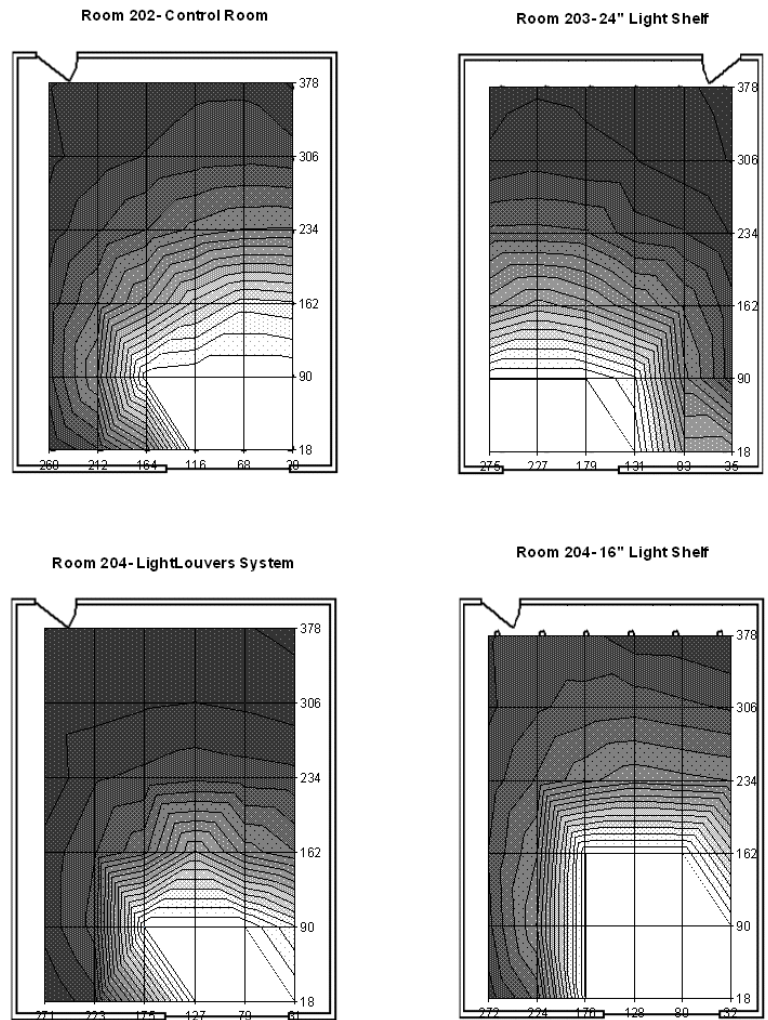
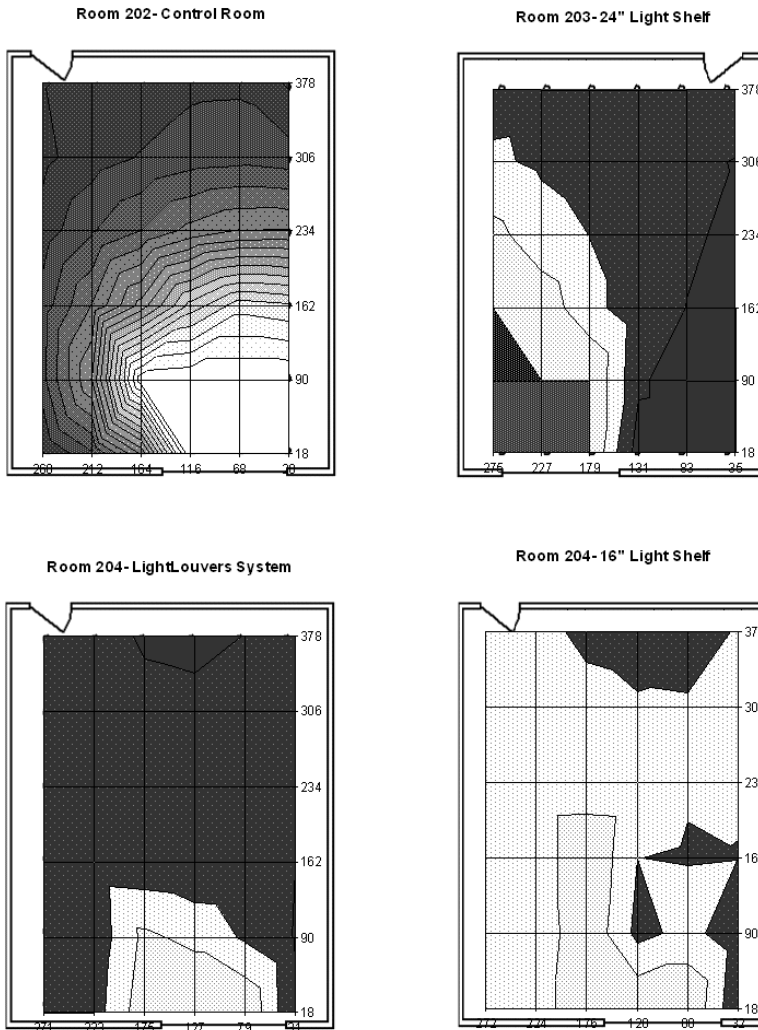

Figure 3. Plots showing average light distribution in classrooms.

Room 204 is fitted with the LightLouver system. For this application two LightLouvers are used. Each of these units is 60 inches wide and extends down 26 inches from the top of the window. LightLouvers are sized to order and only have one design. The entire width of the window is filled with the LightLouvers. This room is used full time as a classroom and has more decorations and a larger percentage of the floor covered than the other classrooms. The floor directly in front of the window is covered with an artificial grass rug. Another rug is located at the front of the classroom behind a wicker sofa. These items were too large to be moved from the classroom for testing. The edge of the window is located 31 inches from the west wall.

Room 205 is fitted with the shorter 16 inch protrusion light shelf. This light shelf is constructed and mounted in the same manner as the long protrusion light shelf. The only differences are that this light shelf protrudes 16 inches from the window and is mounted 15 inches from the top of the window. This room is used as an auxiliary room, mostly for music lessons. It had the most consistently open floor plan and least number of decorations. Most of the furniture except for chairs was pushed to the outside



Results

Data for all rooms was normalized and plotted. Trends for each room were identified and found to be similar in each regardless of time of day, weather, or season. Because of this global similarity, trend averaging for each room was justified in order to more concisely convey the overall performance of the daylighting devices.

Statistical analysis for standard deviation calculation and average of absolute deviation were carried out on all data sets. The lowest standard deviation of 3.09 was seen in the data from the cloudy fall morning for room 203. This data set also possessed the lowest average of absolute deviation at 7.00. The highest standard and average of absolute deviation were 25.49 and 32.72 seen in room 205 during the clear winter evening data set.

Figure 3 shows the light distribution through the classrooms. Each band represents a 0.5% decrease in light intensity. These values start at 10% of available light with the white area shown near the window. The white area on each plot represents intensities greater than 10% which only occur directly in front of the windows.

Figure 4 shows if there is an improvement in light intensity relative to the intensity of the control room. The light areas on the plots represent where the room is brighter than the control room and the dark where it is darker. The exception is Room 203 where the dark area in front of the window represents a significantly greater intensity. This area is represented with the dark gray area in the lower left corner of the plot.

Photographs provide the qualitative comparison between the classrooms. Two examples of these photograph data sets are provided in Figures 5 and 6. Figure 5 shows the photographs taken following the cloudy winter morning data set. The pictures showing the window are not as revealing so they are omitted for space consideration. The arrows show where the room becomes darkest. Figure 6 shows the pictures taken following the clear midday winter data set.

Conclusions

Plots of averaged data show that room 205, the 16" light shelf, provides the most light overall. This room has the deepest light penetration and is the only to show an overall gain in light compared to the control room. The pictures show that room 205 has the deepest light penetration, supporting the numerical results.

The performance of the LightLouver system was disappointing, often returning the worst performance of all the rooms, especially on cloudy days. This is likely due to the difficulty in reflecting diffuse light. The LightLouver system is designed to move direct sunlight deep into the room⁸ but when the light is diffuse it cannot be as effectively reflected. Due to this lack of reflection

Figure 4. Plots showing light intensity relative to control classroom.

edges of the room. The chairs were usually arranged in a semi-circle across the floor of the room. The window edge was located 32 inches from the west wall.

The window for each room extends from about 3 inches from the ceiling to about 32 inches above the floor. These windows have a tint applied to them. This tint likely cancels about 30% of visible light. The 16 inch light shelf is mounted 15 inches from the top of the window and the 24 inch light shelf is mounted 23.5 inches from the top of the window. The LightLouvers cover the top 24" of the window. All daylighting devices span the full width of the window.

Experimentation was carried out as quickly as possible in order to avoid excessive motion of the sun or changing cloud conditions which will adversely effect the accuracy of the measurements. The measuring instrument's sensor¹⁰ was fitted to a tripod and oriented vertically to insure uniform direction and elevation throughout the rooms. Effort was made to remove objects which may have caused shading in the classrooms such as stacked desks and window coverings. Information was collected on worksheets set up for each room with the time of day and weather conditions documented. Photographs were compared side-by-side to gage quality of light entering the rooms.



the light louvers function as blinds, covering the top 24 inches of the window and blocking light that could have entered there.

Performance of the 24 inch light shelf relative to the others is difficult to gage due to the window location near the east wall. With this window location, light encountered the east wall more quickly, with less room to reflect from the ceiling and floor than in the other rooms during evening hours. Due to this we see the area of significantly better performance near the window as shown in Figure 4.

With this comparison of the different daylighting methods JCPS can choose the best fit to their daylighting needs. Future buildings designed to incorporate daylighting may find great ben-

efit from the LightLouvers, however as a retrofit for the relatively shallow and open classrooms, the 16 inch light shelf seems the most appropriate.

Students need about 484 Lux to perform their tasks in class¹¹. The classrooms were investigated relative to this standard and were found to meet this requirement only in the area directly in front of the window on sunny days. This means that auxiliary lighting will be necessary almost all of the time in the classrooms even with the daylighting devices installed.

Education on using the daylighting devices should be given to the teachers who have daylighting devices installed in their classrooms. The teacher who taught in rooms 203 and 204 did not know what the devices mounted to their windows were or what they were supposed to do. The teachers did however miss their blinds since none of the rooms had any sort of shading on the windows. Teaching the teachers that the daylighting devices can be used to lessen the need for artificial light and that they should not add significant heat to their classrooms during operation will help increase the energy efficiency of the schools and the acceptance of the technology.

Proper application of daylighting should include untinted glass to serve light to the daylighting device while the view portion of the glass should be tinted to reduce heat admitted to the room and glare from uncontrolled light. The view portion of the glass should have shades or blinds capable of blocking excess light but not obscuring the daylighting portion of the window. The rooms should have an open floor plan and reflective ceilings as well as automatically dimming lights and face south or slightly east of south to capture more light in the beginning of the day when students are there. Considering these factors, daylighting could be applied to the classrooms by JCPS with great success.

For further evaluation of these devices, a more controlled environment should be established. The rooms should all have the same furniture in the same arrangement with the same wall coverings. All rooms should have the same layout, with windows in the same location, preferably centered on the wall. Shades should also be applied to the windows and testing carried out with them in different positions. Data collection should take place simulta-



Figure 5. Photographs of classrooms from cloudy, morning, winter data set.

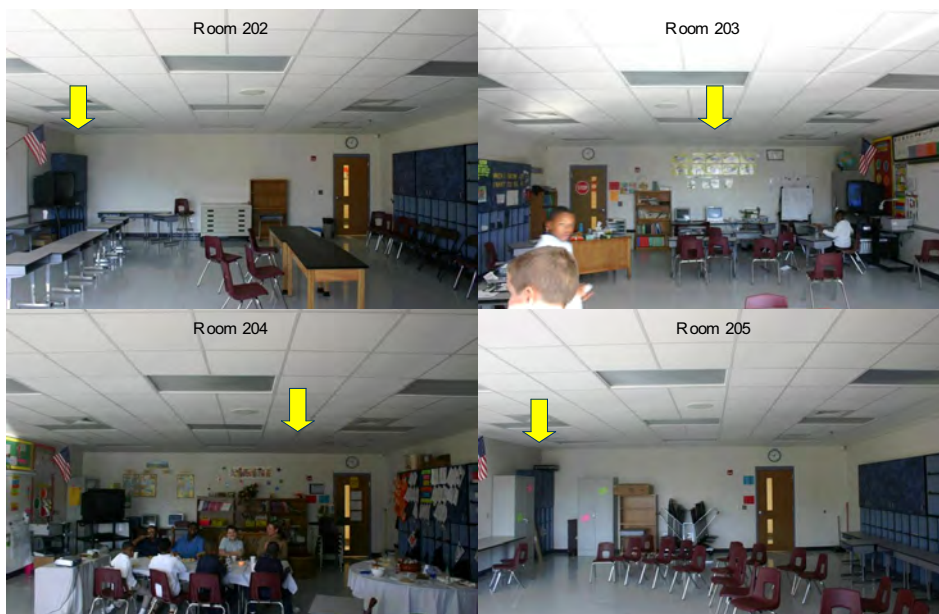

Figure 6. Photographs from sunny, midday, winter measurement.



neously across all of the rooms, with synchronized measurements in order to make sure the same available light is measured in all of the rooms. This would work better, but fully instrumenting the rooms would be ideal, allowing for continuous monitoring of the light intensities at the same time over broader time periods. This data could then be computer analyzed more quickly and provide more complete results.

Eric Biebighauser graduated from Speed Scientific School at The University of Louisville with a Master of Engineering degree in Mechanical Engineering. He is currently employed by Luvata ElectroFin Texas, Inc. as their Engineer and resides in Jacksonville, Texas with his wife Sarah.

References

- “Appleton School District: Appleton Wisconsin,” Daylighting Collaborative, Case Study, http://www.daylighting.org/pubs/appleton_case_study.pdf, Accessed Sept 12, 2006
- Energy Information Administration, Electricity Sales, <http://www.eia.doe.gov/neic/infosheets/electricitysales.html>, Accessed Oct 1, 2006
- Energy Information Administration, Commercial Executive Summary <http://www.eia.doe.gov/emeu/cbecs/cbecs2f.html>, Accessed Oct 1, 2006
- Energy Information Administration, Energy Kids Page, <http://www.eia.doe.gov/kids/energyfacts/saving/efficiency/savingenergy.html> #EnergyConsumption, Accessed Oct 1, 2006
- Heschong Mahone Group, “Daylighting in Schools,” The Pacific Gas and Electric Company, Detailed Report, August 20, 1999.
- “Kentucky’s First Four ENERGY STAR Schools Recognized; Lyle, Lola; July 21, 2006, <http://kentucky.gov/Newsroom/energy/esschools.htm>, Accessed Nov 2, 2006
- “Know how: Classroom Lighting”, Northeast Energy Efficiency Partnerships, Inc., 2002, http://www.designlights.org/downloads/classroom_guide.pdf, Accessed December 3, 2006.
- “LightLouver Performance,” <http://www.lightlouver.com/lightlouver/performance/index.html>, Accessed Sept. 12, 2006.
- “LightLouver Daylighting System Case Study and Performance Results”, Architectural Energy Corporation, Boulder Colorado, August 2003, http://www.lightlouver.com/projectgallery/xilinx_case_study.pdf, Accessed Nov 2,
- Mannix Testing and Measurement, Digital Light Meter, 3 Range <http://www.mannix-inst.com/index.php?section=safety&id=373&subcategory=lightuvemf>, Accessed Oct 1, 2006.
- Relating to Energy Efficiency and Renewable Energy, Executive Order 2006-1297 Governor Ernie Fletcher, October 12, 2006



Investigation of Methods for Proper Stormwater Management on the University of Louisville Campus

Justin Faith, Robert Lucas, Grace Kim, Kathleen Marshall, Kim Nelson, Carol Patel, Marcus Siu

Introduction

Stormwater management on the University of Louisville campus is minimal resulting in water quality problems in the region. The combination of roof gutters that drain directly into Louisville's combined sewer system and impermeable surfaces that cover much of the University of Louisville's Belknap campus has direct ecological consequences for our surrounding water systems. Untreated wastewater that is collected by the sewer system is discharged into the Ohio River about 30-35 times every year via CSOs during extreme rain events. Although designing a system that can restore the predevelopment hydrology of the city is impractical, the university should be proactive in delaying surface water run-off to allow sewer systems to handle the inflow. Potential solutions that could aid in the alleviation of polluting nearby water systems and flooding of the CSOs could include water retention, water detention, and filtration.

Water maintenance has typically been divided into two different areas, water retention and water detention. Within these two classifications, there are a variety of ways to preserve water that include open channels, ponds, infiltration trenches, and filtration. Methods of water retention involve the use of a holding area to contain the excess water until the soil is able to accept it. This initially began with urban areas using above ground pools as large retention centers (7). These pools caused numerous problems from child safety to unpleasant odors and increased insect populations. The city of Louisville has built some retention ponds, however, this idea is not feasible for our campus or city today as there is a shortage of available land in the middle of the city to locate ponds.

Low-impact development (LID) uses many techniques to restore a watershed's predevelopment hydrology. (4) A few of the common LID practices are eliminating impervious surfaces and unnatural disturbances as well as increasing bioretention and reuse of rainwater. Impervious surfaces prevent the natural flow and percolation of storm water into the groundwater system. This

can cause flooding, combined sewer overflows (CSOs) and dramatic changes in riverbank flows. High flows can push bank sediment into the stream leading to bank erosion and collapse of the riparian zone. Unnatural disturbances include mowing, removal of slopes and introduction of non-native species. An option to minimize the area of impervious surfaces and prevent the ill effects from atypical disturbances is bioretention which naturally directs stormwater run-off.

The truly engrossing aspect of low-impact techniques is the cost effectiveness of such systems. Some companies have saved over \$60,000 compared to what would have been paid for concrete drains (7).

Two techniques that could potentially quell the peak rate of excess water run-off include on-line and off-line infiltration systems (3). An on-line infiltration system uses a basin that collects all of the incoming water and when it reaches a designated height flow off. Conversely, the off-line system includes a small, elevated weir that is used to allow the excess water to run off into a side basin. Taking only the peak flow into the basin instead of the entire flow like an on-line system.

After various tests and pilot trials it was determined by Bruce Ferguson that overall off-line filtration was much more feasible than a similar on-line system. Comparatively, the off-line system required a smaller set of basins and due to its increased volume of discharge had a much lower time of retention for the water. However, this increased volume could further create problems such as flooding at drains and culverts.

With the growth of urban areas there has been a large increase in demand for roadways, shopping malls, and residences. This demand results in impermeable surfaces. This practice causes numerous problems for storm drainage systems in regards to run-off as well as water quality. The effect of lower soil absorption of rainfall can have drastic repercussions on storm drainage systems. When a storm drainage system is coupled with sanitary



sewers, i.e. using the same set of drainage pipes, the problem becomes serious. Louisville has the problem of a combined sewage/storm drainage system located beneath its maze of paved surfaces. The city of Louisville will spend approximately \$750 million to reduce these problems in order to comply with an EPA Consent Decree by 2017. A survey of the Belknap Campus revealed that a variety of stormwater management techniques of water retention and detention could help solve this problem and delay surface water run-off from infiltrating the sewer system.

Methodology

The researchers canvassed most of the buildings at the University of Louisville, Belknap Campus and the drains of the buildings were classified into three different categories: number of directly connected drains on the exterior of the building, drains with splash plates, and buildings with all interior drains connected directly to the sewer system. Surface area of the roofs of the buildings on the main campus were calculated using Geographic Information Systems (GIS) software to determine the amount of run-off generated by 25 and 100 year rain events for 6, 12, 24 hour durations. The run-off was calculated into gallons by using the following equation:

$$P = X * C * I * A * (0.623 \text{ gal/in})$$

(1)

where A is the contributing area in square feet. It was multiplied by 0.623 gallons/inch since 1 square foot equals 0.623 gal/in. I denotes the rain intensity in inches/hour. C represents the run-off coefficient of the run-off generated from surfaces. All of the buildings on Belknap Campus with concrete surfaces have an average run-off coefficient of 0.90. X is time period of the rain event in hours. Equation 1 was also used to calculate the gallons of water generated as run-off from parking lots.

Another visual survey was conducted around the buildings that generated the greatest amount of run-off to determine which mitigation technique would be the most effective in reducing the amount of water reaching the sewer system. The options to choose from were bioretention, pervious surfaces, infiltration trenches, rain gardens, wetlands, and green roofs. A site-specific recommendation was made.

Results

The survey of drains showed a vast majority of them directly connected to the sewer system (Table 1). Most buildings have interior drains in which all the water collected by the roof empties into the sewer system. Some buildings have drains that are not connected directly to the sewer system but the area surrounding the drains has no means of water retention allowing the water to percolate and cause campus flooding during rain events.



Two views of the lawn area between Ekstrom Library and 3rd Street depicting the various trees and free space.

With the information collected from the survey of drains, the equation mentioned in the methodology section was used to calculate the amount of run-off generated during a 25 year and 100 year rain event for 6, 12, and 24 hours. (Tables 2 and 4). The run-off coefficient used was 0.9 because that was the average for the impervious surfaces such as concrete and asphalt that cover much of the campus. The total amounts of run-off that have been generated in each of the events can be seen in the tables. All the events totalled would generate over 1.5 million gallons of water as run-off entering the sewer system.

Of particular interest were the amounts of water collected from the buildings with direct connections (Tables 3 and 5). On the Belknap Campus, there are approximately 44 buildings that have direct pipe connections that drain into the sewer system. This adds up to roughly 1,185,395 square feet of roof top area that collects 738,501 gallons per inch during rain events.

The area of impervious surfaces from only the rooftops of all the buildings on Belknap campus sums to about 2,288,263.25 square feet. Similar calculation of the area of impervious surfaces resulting from parking lots is about 1,686,186.32 square feet. The amount of run-off from all of the parking lots was calculated for the same 25 and 100 year storm events for 6, 12, and 24 hours. The specific gallons of run-off can be found in Tables 6 and 7.

RECOMMENDATIONS

Bioretention

A major factor in the large amounts of rainwater run-off on the University of Louisville campus is the large amount of space occupied by buildings. These buildings cause the water to be constricted into much smaller areas of permeable surface and often the drains from roofs are directly connected to the pipe system underneath the buildings. The direct connection of drainage pipes creates a heavy load on the sewer system especially in the area around the recently renovated library. The Ekstrom Library and the Speed Art Museum have large amounts of discharge due to large surface areas. For a 25 year storm they contribute 158,777.66 and 158,819.81 gallons of water run-off in 24 hours.



Conveniently, there is a large amount of unimproved ground located in the gap between Ekstrom Library and 3rd Street that also connects to the Speed Art Museum and the Law School. This lot is surrounded by sidewalks that divide the area into two equal pieces. In this lot there are a number of trees that provide coverage but are ineffective for many quick rains that Louisville experiences. According to the Center for Urban Forest Research, a tree provides better water retention for a one inch rainfall over two days than a one inch rainfall over two hours¹. Additionally, the soil found around campus has high clay content and is very poor in water retention. In fact, according to the NOAA, soil that is well drained (i.e. sandy) has a run-off coefficient of 0.05-0.20 while clay soil is 0.13-0.35.

The open area in front of the library can be effectively used as a means to dispense the run-off over a larger area of land and act as a bioretention area. This filtering has shown up to 98% removal of oil and grease in both field tests and column study experiments³ as well as the ability bioretention cells have shown in reducing peak flow during storm events. Values for smaller rain events, especially those less than 40 mm, were mitigated by 96%³.

Bioretention is also a practice that is cost-effective and easily put in place. Bioretention cells have been described as landscaped depressions in which storm water drainage is diverted and stored⁴.

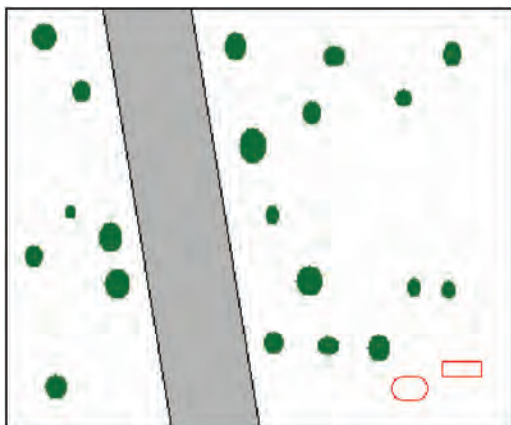

Illustration depicting the region of lawn and location of trees and the sidewalk.

The water is treated both by the uptake from various plants, shrubs, and trees placed inside the cell in addition to the ability of the water to then infiltrate into the soil beneath the bed. However, half of the run-off from each of the three buildings can be shuttled into bioretention strips located in this adjacent lot.

Many of the buildings contain direct contact with the sewer system and these connections will have to be diverted in order to run the water into bioretention cells. Once the connections have been severed and redirected to the correct locations it will then be necessary to create a perforated pipe system that will allow the water to percolate through the area. The pipe design developed by Sendor Gyorgy Kiss P.E. would provide an effective method for water redistribution⁵. The pipe can be intermittent portions of perforation and solid pipe in order to facilitate running the pipe under sidewalks or parking lots. The solid area of the pipe would sit under the paved surfaces to avoid water flowing into the ground under these developed portions and possibly ruining the foundation. Likewise, the perforated areas would be placed under the exposed ground. However, the depth at which these pipes should be buried is specific to the actual location. There are locations that contain large amounts of relatively impervious soil; therefore, to effectively allow the water to infiltrate, the depth must be determined by finding where there is finer soil to better facilitate the inflow of water.

The major problem encountered in the development of the bioretention cells is the ability to work around the trees that are already present in the lot. The bioretention cells will have to be developed around the already present trees. However, studies on cost effectiveness for both operating and management of low impact developments suggest that to maintain a bioretention cell would only require approximately 5% of its construction cost⁴. Looking at the figure the dimensions are approximately 71 yards wide by 60 yards long with the sidewalk intersecting along either

width. The sidewalk is approximately 4 yards wide and the various green dots are the trees found in the lot. One obstacle is the red oval which is a conglomeration of pipes and concrete that could pose potential problems for removal to setup a bioretention bed.

The lack of expertise and research on this particular method of water retention would provide a wonderful opportunity for the university to act as a pilot in the progression of storm-water retention. Depending on the actual design and ability to maneuver around the pre-existing trees, the lot could contain 2700 gallons in a simple 30 ft wide x 30 ft long x 3 ft deep shape. The exact cost is not known, but various studies show the construction cost to be relatively modest⁴. The beds would not require much more than initial soiling and routine maintenance similar to any garden. In fact, according to T.E. Scott of bioretention.com the only required maintenance would be weeding, mulching, replanting, and making sure the area is free of trash and debris.

Subsurface Wetlands

The land between the Belknap Research Building (BRB) and Crawford gymnasium (W1) as well as that between Dougherty Hall, Patterson Hall, Brigman Hall and the International House (W2) are rarely used but significantly contribute to campus flooding. The area between the BRB and Crawford gym (W1) contains 19,868.800 ft² (2,207.644 yd²) experiences 353,894.6 gallons of storm water run-off over 24 hours during a 100 year storm. During each day of a 100 year storm, approximately 151,079 gallons of storm water runs into the area near Dougherty Hall (W2) which contains 7955.514 ft², or 883.946 yd². The land between the Belknap Research Building and Crawford gym is downwardly sloped towards Brook St., which often forces water into the street. The area near Dougherty Hall is flatter but sits atop of a very steep hill which slopes down to Third St. During rain events, this area (W2) often floods causing water to flow into Third St., which contributes to the flooding of the intersection at Third St. and



Eastern Pkwy. Therefore we propose the introduction of subsurface wetlands in these areas to decrease campus flooding and delay surface water release into the sewer system.

Subsurface wetlands allow the treatment and absorption of water without open water. The lack of open water found in subsurface wetlands discourages mosquitoes and decreases liability risks, which are often associated with surface wetlands. Also, subsurface wetlands contain more surface area for absorption and bioremediation than natural wetlands, so these systems are often much smaller than open water wetlands. Subsurface wetlands are suitable for sites with less than 60,000 gallons/day (5). Since the considered sites typically experience less than this amount during rain events, the wetlands should accommodate most storms. Also, any overflowing of the wetlands will be transported directly into the sewer system by current drains.

The site between the Belknap Research Building and Crawford gym (W1) would be a tiered subsurface wetland to accommodate the sloping land. A levee between the levels with an overflow pipe to connect the levels would be used to prevent the overflow of storm water from the wetland. Current drains would also be used to transport any overflow directly to the sewer.

The site near Dougherty Hall (W2) would be a single-tiered subsurface wetland. This site would use current drains for removal of overflow water to the sewer system. Before construction the underground electrical line must be removed from this area.

Each site would use similar materials, which would decrease costs. Removal of land would require approximately \$1,000 and one day per site. Piping would cost approximately \$200 to \$300 total. Gravel, used to increase percolation, would cost at most (using an average of two inches of gravel over the entire wetland area) approximately \$10,000 for W1, \$4,200 for W2 and a total near \$14,200 for both wetlands, considering \$70-\$80 per cubic yard. However this cost could be dramatically decreased by picking up the gravel rather than having it delivered. Native riparian plants such as jewel weed, spice bush or papaw and trees such as red maple, silver maple, dogwood, tulip poplar or sycamore would be placed for approximately \$500 to \$600 per wetland. Construction of each site could be completed in 2 to 7 days. Therefore the projected cost of W1 is \$11,650 and W2 is \$5,850.

Pervious Pavement

Many large roads and parking lots are constructed with asphalt. Asphalt is a heavy hydrocarbon substance derived from the residue of crude oil (after gasoline, kerosene and other fractions have been removed), and has total run-off during any precipitation. Asphalt surfaces make storm water management difficult, but also is detrimental to the environment—particularly to our water system as rain water oxidizes a large number of polar constituents in asphalt and takes it away to the streams. More problematic are the cars parked on asphalt surfaces on sunny days. They become very hot causing automotive fuels to boil over

which ultimately are washed into the storm sewers and end up in the environment.

On even small storm events, many of the parking lots on the university campus are flooded and pedestrians find it difficult to walk through them without getting wet. The top three water run-off parking lots on campus were targeted: the southeast parking lot (PL#1), southwest parking lot (PL#2) and the northeast parking lot (PL#3). Coincidentally, all these lots are near railroad tracks, causing the storm water run-off to have more pollutants than the already existing contaminants.

The Solution: Pervious Paving

Pervious pavement consists of gravel or stone, cement, water, sand and geo-textile fabric. With little or no sand in this mixture, an open cell structure is created allowing storm water to filter through the pavement and into the underlying soils. Pervious pavement usually has 18% to 40% porosity allowing five gallons of water per minute for each square foot of surface area to pass through it. This system effectively reduces storm water run-off while replenishing groundwater and keeping water cleaner.

The volume of a 5-inch thick pervious concrete pavement can retain up to an inch of rainwater before run-off occurs or water is percolated into the soil. In addition, the open cells allow aerobic bacteria to grow, which break down pollutants such as oil and other hydro-carbon liquids that seep from parked cars. This helps to prevent much of the polluted run-off that normally occurs with traditional pavements. According to the US EPA, 90 percent of pollutants are typically carried by the first 1-1/2 in. of rainfall through traditional horizontal run-off into rivers and streams.

Pervious pavement has a life of ten to twenty years and is recyclable. Studies indicate that clogged pavement can be pressure washed to restore 80-90% of the permeability. Also, concerns about the freeze-thaw that causes so many cracks in asphalt seems to be less of a problem due to the porosity of the pavement as air trapped inside the pavement makes for more rapid temperature adjustments which prevents expansion and contraction.

RECOMMENDATIONS

Parking Lot # 1

This parking lot is one that needs the most attention because it is in such terrible condition. Even in a small rain event, the impervious surface had collected water in ponds under the bridge on Old Eastern highway. Throughout the parking lot, water ponds were visible and the asphalt was in damaged condition with wide cracks and patched areas.

Because everything about this lot is problematic, the recommendation is to pave the whole parking lot with a pervious concrete. The total area of this lot is about 71,990 ft² and its water run-off is about 44,850.02 gallons/inch. Within 24 hours of a 25-y storm event, this lot will run off 280,940.52 gallons/inch.



Photos showing the run-off near Old Eastern Parkway and the damaged surface of Parking Lot #1.



Parking Lot #2.



Parking Lot #3.

The pervious pavement can handle approximately four gallons of rain per ft² in a minute, so 287,969 gallons of water will be passing through this lot, successfully managing the storm water run-off. The approximate total cost of redoing this parking lot is around \$370,000.

Parking Lot # 2

The area around this parking lot, especially on Third Street, always has a flood problem. To manage the storm water problem on this side of campus, putting pervious pavement on this lot is the best

solution, however, there is no need to redo the whole parking lot since the condition of this lot is not as bad as the first lot. To make this project cost effective, the recommendation is to pave only the edges of the parking lot where most of the run-off occurs.

The topography shows that most of the water flows mainly toward two corners of the parking lot: northwest end and the southwest end. As the GIS map indicates, the line that separates the northern lot and southern lot is geographically the highest level of the parking lot. From thereon, all the water flows down to the western and southern edges.

The total area of this lot is about 212,368 ft² and its water run-off is about 132,305.26 gallons/inch. Within 24 hours of a 25-yr storm event, this lot will run off 828,760.17 gallons/inch. The total area that needs pervious pavement renovation on the western and southern edge of the parking lot is 54,975 ft². The approximate total cost of redoing the lot is around \$220,000.

Parking Lot # 3

This parking lot is the largest parking area on campus and has significant run-off. Unlike the second lot, the topography is not as favorable to do much with. A method similar to that used on the second lot with pervious pavement on the northern and eastern edges of the parking lot and the small lot on the very south would work. This latter lot, located at the lowest level from other parts of the lot, will basically act as a small retention pond.

Pervious pavement should be placed on this lot because most of the storm water from it will run off onto Third Street. Located on higher ground from other parts of the campus, this parking lot will eventually let the run-off water flow down to the southwest corner of the campus, the flood corner. Therefore, it is vital that pervious concrete be laid around the edges of the parking lot on the Third Street side to retain as much water uphill as possible for some period of time before it flows on.

The total area of this lot is about 475,515 ft² and its water run-off is about 296,245.85 gallons/inch. Within 24 hours of a 25-yr storm event, this lot will run off 1,855,683.97 gallons/inch. The total area that needs renovation of the pervious pavement on the western and southern edge of the parking lot is 53,582 ft². The approximate total cost of redoing the indicated areas of this parking lot is around \$215,000.

Other Benefits

Pervious pavements definitely conserve water. Because of the resulting percolation, the run-off to the environment is cooler and cleaner and the groundwater can be recharged. Adjacent landscaping will receive more water therefore requiring less need for irrigation.

Ultimately, the money spent on labor, construction, and maintenance of water management facilities such as retention ponds, skimmers, pumps, and irrigation systems can be reduced or eliminated. It can also mean that valuable land normally



used for discharge and run-off mitigation can be developed for commercial gain. Owners, developers, architects and engineers using pervious concrete can take advantage of important benefits. This product can help satisfy certain EPA drainage and storm water discharge requirements. Although initial cost may be higher than asphalt, because of high durability and strength and its ability to be recycled, pervious pavement would pay off in the long run.

Green Roofs

Many buildings on the campus drain run-off directly into the sewer system. Green roofs capture run-off that would otherwise enter the sewer system and they would immediately reduce the area of impervious surfaces covering the campus.

Based on the survey of areas of buildings, the top fifteen were investigated aerially to determine which roofs had a flat surface to host a green roof. Three buildings chosen as candidates to host a green roof were the following: Schneider Hall, Life Sciences Building, and two parts of the Student Activities Center (SAC). The SAC has a multileveled roof but it had two portions that were flat with areas of 16,718.7 square feet and 52,998.9 square feet. The SAC is the largest building on campus. It generates about 812,177 gallons/inch of run-off during rain events. The Life Sciences Building generates 23,061 gallons/inch of rainfall and Schneider Hall generates about 21,608 gallons/inch of run-off. All three buildings have interior drains that connect to the sewer system.

Vegetated rooftops absorb the water before it can infiltrate the drains. The type of roof that is ideal for university buildings are extensive green roofs versus the intensive green roof. Extensive eco-roofs hold just the vegetation and are not made to hold large groups of people. They also require little maintenance compared to the intensive roofs which grow larger vegetation such as trees and shrubs. Extensive green roofs are less expensive to construct and maintain as well.

For extensive roofs, materials include a waterproofing liner, a drainage mat, soil medium to allow the vegetation to grow, and native plants that can adapt to extreme climates. The drainage mat is placed over the liner. The mat consists of storage cups that are able to store water for vegetation. The soil medium is a mixture of natural soil and other lightweight materials such as clay, shale, and slate (Hunt).

The critical part of the green roof is the type of vegetation that is grown. It has to be low-lying and able to withstand harsh conditions such as extremely hot weather, periods of dry conditions, and copious amounts of sunlight. There are two types of grasses that are Kentucky natives and ideal for growing on top of a green roof: prairie switchgrass (*Panicum virgatum*) and sideoats grama (*Bouteloua curtipendula*). Both of these grasses prefer drier sandy or clay soils and tend not to be sustained in rich soil. Both prairie switchgrass and sideoats grama thrive in full sunlight

and tend to lose their columnar stature in shade. The grasses' ability to grow in harsher conditions will allow them to flourish on the green roofs.

Wildflowers are another kind of vegetation that should be considered. There are many that are native to Kentucky and are able to grow in dry to medium soils with full sun. Table 1 shows their scientific and common names.

Scientific Name:	Common Name:
<i>Yucca filamentosa</i>	Adam's Needle
<i>Echinacea purpurea</i>	Purple Coneflower
<i>Coreopsis lanceolata</i>	Tickseed
<i>Solidago ulmifolia</i>	Goldenrod
<i>Solidago nemoralis</i>	Goldenrod
<i>Solidago odora</i>	Sweet Goldenrod
<i>Solidago rigida</i>	Goldenrod
<i>Solidago speciosa</i>	Goldenrod
<i>Oenothera speciosa</i>	Evening Primrose
<i>Rudbeckia hirta</i>	Black-eyed Susan

Table 1: Summary of wildflowers that are ideal to grow on green roofs.

Green roofs take advantage of evapotranspiration to reduce the amount of run-off that would enter the sewer system. The soil media absorbs the rainwater as it falls and the vegetation soaks up the water. The water is later released back into the atmosphere through the process of evapotranspiration. The plastic cups that are present in the drainage mat catch additional water and store it for use by the plants during non-rain events. Excess water that is not absorbed or dried is directed into the drains that empty into the sewer system.

The cost of the material is expensive not only because they are unique but also because the process of constructing the green roof is extensive. The materials have to be hauled onto the roof and the roof has to be prepared to host a green roof structurally. For that reason the projected cost of most green roofs is about \$25 per square foot. Table 2 shows the estimation of prices of building a green roof on the three buildings.

Building	Area (ft ²)	Projected Cost
Life Sciences	36008.8	\$ 900,220
Schneider Hall	34882.8	\$ 872,070
SAC (1)	52998.9	\$ 1,324,973
SAC (2)	16718.7	\$ 417,967.5

Table 2: Summary of estimated costs of green roofs on the three buildings chosen with the assumption that the cost of materials is about \$25 per square foot.



To reduce the amount of impervious surface on the Student Activities Center, the largest building on Belknap Campus, the total cost would be around \$1,742,940.50.

Green roofs prevent the temperature of the roof from fluctuating greatly from night to day. This prevents contractions and expansions of the roof thwarting premature cracks to the foundation extending the roof life. Besides extending the roof life, the green roof also insulates the building reducing the amount of heating and air conditioning needed by that building. The amount of savings depends on factors such as the amount of soil media, types of vegetation planted, and roof construction and location (Beattie). Also, green roofs reduce the urban heat island effect which creates areas of higher temperatures around developed and paved regions.

Rain Gardens

There are several simple economically feasible, water management techniques that the University could implement quickly to delay surface water releases in order to give the sewer systems more time to handle the inflow. Among the simplest of these is the rain garden.

The best realistic and economical approach to water management is through a good long-term site design such as implementing rain gardens. Rain gardens are an economically feasible option for providing the campus with a green infrastructure. These landscaping features are adapted to provide on-site treatment of storm water run-off. The most attractive feature of the rain garden is its simplicity and cheap cost.

The numerous beneficial functions campus rain gardens

would serve include removing pollutants, helping keep water from campus clean by filtering storm water run-off before it reaches streams or rivers, alleviating the recurrent campus flooding problems, enhancing the beautification project of the University, reducing the need to mow which cuts costs, and helping replenish the ground water supply.

We conducted extensive research on the best ways and locations to implement rain gardens by approximating the amount of rain that comes off each building during storms. The task of building rain gardens around campus could be done in a cost effective and educational manner by using students. Based on our analysis of the rain statistics, our group recommends placing rain gardens in 5-8 locations on campus. Those locations are listed below with the amount of run-off generated from the rooftops from the surrounding buildings.

Location 1: Strickler Hall and Davidson Hall

We recommended rain gardens be placed in the southwest corner of both Strickler and Davidson Halls, and on the southeast corner of Davidson Hall. These locations are ideal for rain gardens because they are chained off sections of flat grass where students typically do not walk or congregate. Strickler Hall roof generates about 20,770 gallons/in of run-off and Davidson generates about 17,710 gallon/inch of run-off.

Location 2: Gardiner Hall

We recommended rain gardens be placed in the northeast, southeast and southwest corners of Gardiner Hall. These locations are ideal for rain gardens because they are sections of flat grass where students typically do not walk or congregate.

Scientific Name:	Common Name	Season	Classification
<i>Aquilegia canadense</i>	Columbine	Spring	Wildflower
<i>Baptista alba</i>	Indigo	Spring/Summer	Wildflower
<i>Desmanthus ilinoensis</i>	Illinois Bundleflower	Early summer	Wildflower
<i>Asclepias syriaca</i>	Common Milkweed	Summer	Wildflower
<i>Polymnia canadensis</i>	Leaf Cup	Summer	Wildflower
<i>Eupatorium fistulosum</i>	Joe-Eye Weed	Late summer	Wildflower
<i>Aster novae-angliae</i>	New England Aster	Fall	Wildflower
<i>Rudbeckia hirta</i>	Black-eyed Susan	Fall	Wildflower
<i>Soldiago sp.</i>	Goldenrods	Fall	Wildflower
<i>Helianthus angustifolius</i>	Narrow-leafed Sunflower	Fall	Wildflower
<i>Silphium pinnaatifidum</i>	Cut-leaf Prairie Dock	Fall	Wildflower
<i>Sporobolus heterolepis</i>	Prairie Dropseed	Summer	Grass
<i>Hystrix patula</i>	Bottlebrush Grass	Early to late Summer	Grass
<i>Andropogon scoparium</i>	Little Bluestem	Summer	Grass
<i>Carex fankii</i>	Fox Sedge	Summer	Grass

Table 3: Summary of native vegetation of Kentucky suitable to plant in rain gardens.



Gardinar Hall generates about 4,570 gal/inch of run-off from the roof that could be collected by strategically placed rain gardens.

Location 3: Law School Courtyard

We recommended rain gardens be placed in both courtyards of the law school. These locations are ideal for rain gardens because they are sections of flat grass where students typically do not walk or congregate. The location of the two rain gardens in the center of the building will allow it to catch more of the run-off from the building. The roof collects about 27,277 gallons/inch. Some of the water can be used to sustain the rain garden and only a minimal amount would enter the sewer system.

Location 4: Grawemeyer Hall

We recommended rain gardens be placed in all four corners surrounding Grawemeyer Hall. Rain gardens located all around the office of President Ramsey would serve as a symbolic commitment to the University's proactive steps in pursuing a greener campus. These locations are ideal for rain gardens because they are sections of flat grass where students typically do not walk or congregate. Based on the amount of rainfall for a given 10 year storm, this rain garden could reduce CSO's effect by collecting some of the 8,948 gallons/inch run-off generated by the building..

Location 5: Patterson Hall, McCandless Hall and Dougherty Hall

We recommended rain gardens be placed in the northwest and southwest corners of both McCandless and Patterson Halls, and on the south side of Dougherty Hall. Patterson Hall generates about 3,542 gal/in, McCandless Hall generates about 2,046 gal/in of run-off, and Dougherty Hall generates about 8,511 gal/in of run-off from the building.

Location 6: Miller Info Technology Building and Chemistry Building

We recommended rain gardens be placed in the southeast corners of both Miller Info Technology Building and Chemistry Building. Miller IT Center generates about 28,788.4 gallons/inch of rain and the chemistry building generates about 16,538 gallons/inch of run-off.

We have summarized the simple steps it takes to make a rain garden (all which can be found in MSD handouts or at www.msdlouky.org.) in the following section:

Use the following steps to build U of L's 1st ever rain garden today:

Step 1: Find the Best Location

The location should be both practical and beneficial to campus. The rain garden should probably be located at least 10 feet from the building foundation, but should be close enough to the

source of water run-off so that water can travel to the bed. Try to locate your garden where it captures as much run-off as possible, and where it is a fairly flat location.

Step 2: Evaluate the Soil

The soil texture will determine how well water will soak through the soil. The texture of soil consists of sand, silt, and clay, and can be determined by grabbing moist soil and pressing it between your fingers. Rain gardens should be designed to absorb water and not leave standing water. Make sure your soil's clay content is proper to ensure drainage.

The soil composition at the University of Louisville is unknown due to many disturbances over many years. The Natural Resources Conservation Service (NRCS) show in their electronic soil survey as Belknap campus being "urban land". In a description of "urban land" they state that generally the depth to bedrock is 80 inches, and the depth to groundwater is 12-48 inches. The soils do have high clay content. To verify this, NRCS can do a soil survey at the Belknap campus costing the university \$0 and they are willing to dig down 48 inches to determine soil content.

Step 3: Plan the Rain Garden

The rain garden can be any size or shape you wish to make it. You can figure out the surface area of the rain garden by calculating the drainage area needed for it. Simply multiply the length and width of the building together, and then divide by the number of downspouts to get your result. The depth of your garden should be deep enough to drain within 24 hours. Most residential gardens are 4-8 inches deep.

Step 4: Select Plants and Design the Layout

It is very important to use native plants if possible over non-native species. It is recommended to keep taller plants toward the back of the garden, and place shorter plants toward the front. Make sure your plants have the proper sunshine or shade they need. You can place a bird house or bath near the garden to attract birds.

Our group recommends native plants such as "*Asarum caudatum*, *Solidago sp.*, *Polymnia canadensis* and *Hystrix patula*" (ie wild ginger, goldenrods, leaf cups, bottlebrush grass, etc etc.).

Step 5: Prepare the Garden Bed

Outline the edges of the garden before beginning digging. You can kill the grass before digging to make the process easier. Once you have planned out your garden and have the set up, begin digging and planting your garden. Make sure you fill your holes firmly after planting the plants.

Our group recommends students do this work through either an honors environmental class or the work-study program. These low-priced rain gardens can be constructed in a few days.



Step 6: Maintain your Garden

Your garden will need basic maintenance in order to stay healthy and function properly. Make sure to water the garden regularly, mulch the garden to keep the soil moist, and pull out any weeds. Never use fertilizer or spray near your rain garden.

These basic maintenance tasks can easily be accomplished without much alteration to the University's existing grounds crew work. Other colleges and universities such as the University of Maryland and the University of Georgia have successfully implemented rain gardens on their campuses.

Infiltration Trenches

When one begins looking for ways to reduce the peak flow of water off large parking lots during rain events, infiltration trenches are a possible solution. If the parking surface cannot be made permeable in the short term, capturing the run-off would be the next best thing. However, there are certain requirements that must be met for such infiltration procedures to work smoothly and to be worth the effort in maintenance. As we step through these requirements, it will become evident why simple infiltration trenches are not being recommended as a means of stormwater management on the University of Louisville Belknap Campus.

A well designed infiltration trench will drain within 24 hours after a rain event (Stormwater Management Fact Sheet) which aids with maintenance, keeping the trench from clogging. In order for this infiltration rate to be possible, the soil needs to be less than 20% clay (Stormwater Management Fact Sheet). The soil on campus is mostly clay, and after rain events water does not infiltrate from puddles on the ground. Though an infiltration trench would provide more surface area through which water could seep into the ground, the soil becomes more compacted as it gets farther below the surface, which would decrease the rate of infiltration. It is also recommended that the slope of the area served by an infiltration trench be less than 15% (Infiltration Trench).

A French Drain system can be installed, which is an infiltration trench with a perforated pipe running away from it at the bottom. A trench could be used as a storage area with a small pipe at the bottom connecting the trench to the sewage pipe, but greatly reducing flow into the pipe and spreading it over a longer period of time.

Along the sidewalk between Lutz Hall and Crawford Gym is the area proposed for an infiltration trench. Though the soil type is the same, this area would be more feasible for a typical infiltration trench. Due to the nature of the area being drained, grassy, permeable and small, there would not be a large amount of run-off to be captured by an infiltration trench in this location. Putting an infiltration trench here would help to prevent flooding on the sidewalk used by everyone entering the center of campus from the East Entrance by Lutz Hall. It would also prevent this water from crossing the sidewalk and flowing across either a parking lot or a small grassy area to a roadside drain that inevitably leads to a combined sewer.

The cost of infiltration trenches has been estimated at roughly \$5 per cubic foot of water treated, with maintenance around another 20% of the original cost (Stormwater Management Fact Sheet). French Drains have been estimated at \$25 per foot of drain, with much of the cost being labor (Building and Installing a French Drain).

References

- 1 Bonnin, G.W., Martin, D., Lin, B. Parzybok, T., Yekta, M., and Riley, D. "Louisville WSO Airport, Kentucky" Precipitation Frequency Atlas of the United States. NOAA, 11 Feb. 2008.
- 2 Building and Installing a French Drain. Galt Technology. <<http://www.galttech.com/research/household-DIY-tools/french-drain-installation.php>>
- 3 Chemical and Engineering News. "What's that stuff? Asphalt." [25 April 2008] <<http://pubs.acs.org/cen/whatstuff/stuff/7747scit6.html>>
- 4 Cherry, Shane et al. "Related Outcomes of Constructed Wetlands" Wetlands and Water Quality Trading: Review of Current Science and Economic Practices with Selected Case Studies. United States Environmental Protection Agency, 1997. 19-22.
- 5 Croce, Phyllis. A How-to Guide for Building your Own Rain Garden. 2007 31 Jan. 2008 <www.msdlouky.org>.
- 6 Ferguson, Bruce. "Storm-Water Infiltration For Peak-Flow Control." Journal of Irrigation and Drainage Engineering (1995): 463-466.
- 7 Greenroofs. American Plants. 2003. 23 April 2008. <http://www.greenroofs.com/Greenroofs101/plants_for_us.htm>
- 8 Gyorgy-Kiss, Sandy. "Drain Pipe System Manages Stormwater, Rainwater and High Groundwater." Water: Engineering and Management. (1999): 33-35.
- 9 Hutchinson, Doug, Abrams, Peter, Retzlaff, Ryan, and Tom Liptan. "Stormwater Monitoring Two Ecoroofs in Portland, Oregon, USA." Greening Rooftops for Sustainable Communities. (2003).
- 10 Hunt, W.F., Smith, J.T., Jadlocki, S.J., Hathaway, J.M., and Eubanks, P.R. "Pollutant. Removal and Peak Flow Mitigation by a Bioretention Cell in Urban Charlotte, N.C." Journal of Environmental Engineering. (2008): 403-408.
- 11 Infiltration Trench. <http://www.cabmphandbooks.com/Documents/Development/TC-10.pdf> (12) Jones, Jeffery M. "Polluted drinking water was no. 1 concern before AP report." (2008). <<http://www.gallup.com/poll/104932/Polluted-Drinking-Water-No-Concern-Before-Report.aspx>>



- 12 Kentucky Ready Mix Concrete Association. "Pervious Concrete: Pavement That Drinks." [25 April 2008] <<http://www.krmca.org/pervious.htm>>
- 13 National Ready Mixed Concrete Association. "Pervious Concrete Pavement." 25 April 2008 <<http://www.perviouspavement.org/>>
- 14 Scott, T.E. Bioretention.com: A resource for Designers. 6 Sept 2007 (12 Apr 2008) <http://www.bioretention.com>
- 15 Shooting Star Nursery. Shooting Star Nursery. 2007. 23 April 2008. <<http://www.shootingstarnursery.com/index.html>>
- 16 Stormwater Management Fact Sheet: Infiltration Trench. <http://www.stormwatercenter.net/Assorted%20Fact%20Sheets/Tool6_Stormwater_Practices/Infiltration%20Practice/Infiltration%20Trench.htm>
- 17 United States Environmental Protection Agency. Reducing Stormwater Costs through Low Impact Development (LID) Strategies and Practices. Dec. 2007. 31 Jan. 2008 <www.epa.gov/nps/lid>.
- 18 United States Environmental Protection Agency. "Wetlands: Subsurface Flow" Wastewater Technology Fact Sheet. 2000. 24 April 2008 <http://www.epa.gov/owmitnet/mtb/wetlands-subsurface_flow.pdf>.
- 19 University of New Hampshire Stormwater Center. "Treatment Unit Fact Sheet." 25 April 2008. <http://www.unh.edu/erg/cstev/fact_sheets/index.htm>
- 20 Weiss, Peter T., Gulliver, John S., and Erickson, Andrew J. "Cost and Pollutant Removal of Storm-Water Treatment Practices." *Journal of Water Resources Planning and Management.* (2007): 218-229.
- 21 Xiao, Q.F., et. al. "Rainfall Interception by Sacramento's Urban Forest." *J. Arbor.* 24 (4): 235-244.
- 22 Zimoch, Rebecca. "Let It Rain (If You Have the Right Drainage)." *Water Engineering and Management* Oct. 1999: 10.



University of Louisville Student Food Survey

Joshua Porter, D. Westley Miller,
Tyler Lloyd, Samantha Colvin, Lee Young

Introduction

We conducted a study on the eating behaviors and opinions regarding food services of resident students living in traditional dormitories on the Belknap Campus of the University of Louisville. Our study design included a three-day food diary and fifteen-question survey. The study population consisted of resident students living in seven traditional dormitories on Belknap Campus.

The study addressed three primary concerns. The first relates to the subjective level of satisfaction of resident students with current food services offered at the University of Louisville, as well as the degree to which resident meal plan holders are fulfilling their nutritional needs. The University of Louisville outsources food services to Chartwells, Inc. Resident students living in traditional dormitories are required to purchase a mandatory meal plan at the beginning of each academic year. This money can only be spent at on-campus restaurants and convenience stores that are either sub-contracted by, or internal operations of Chartwells.

For first-year students living on campus, the cost of this meal plan is \$995 per semester, and a \$560 per semester meal plan is required by all other resident students. We hypothesized that students for whom this meal-plan is mandatory are not entirely satisfied with the food services offered, and may not be maintaining proper dietary habits. It is only fair to students who are required to purchase this meal-plan that their dietary needs be readily fulfilled, especially in light of the fact that those who fail to spend their entire meal-plan fund by the close of the spring semester are not reimbursed for the remaining balance. Rather, Chartwells is mandated by contract to invest any residual capital directly into University food facilities. This brings us to our second primary research concern.

Because Chartwells is required to reinvest any residual meal-plan money into campus facilities (e.g. dishwashers, utensils, heat-lamps for hot bars), it is in the company's best interest to ensure that all resident students are spending their meal-plan funds in full. If figured in terms of money allocated for food per

day, the first-year resident meal-plan comes to only \$8.80 per day per semester, or \$2.93 per meal if three meals are consumed every day. This figure is significantly lower than what would be predicted for the daily food expenditure of an average college student. However, we hypothesize that many students may still find it difficult to exhaust their entire meal-plan each semester. This is not cost-effective for students or for Chartwells. Therefore, one major goal of this study is to examine why some students may not be fully using the meal-plan even though it has already been paid for, and to offer potential solutions to this problem. Both Chartwells and meal-plan holders would benefit financially from such measures.

Finally, this study will have direct implications for the development of campus community, which has been a primary initiative of University administration for several years. We predict that a paucity of variety in food choices in conjunction with time restrictions imposed by limited late-night hours of operation of on-campus dining facilities may be significant drivers for students spending greater time off campus. Tim Goral (2003: 52) writes, "Today a well-run campus food service can not only satisfy a broad range of appetites, but it can also be a key element for recruiting and can help generate institutional revenue via lucrative partnerships and side ventures."

We believe that the establishment of late-night dining on campus would better accommodate late-night eaters. Furthermore, if combined with a recreational/entertainment center, such a facility could provide greater incentive for students to remain on campus for the fulfillment of both dietary and recreational requirements. By augmenting student presence on campus, such measures could become an instrumental step towards fostering campus community.

Food Records: Overview of Methodology

Darna L. Dufour and Nicolette I. Teufel (Moran, ed. 1995: 97-124) describe three methods of quantitative data collection on food consumption: 1.) food frequencies, 2.) food lists, and 3.) food records. According to Dufour and Teufel, "In progression,



each level provides a more detailed quantitative description of the diet.” (ibid: 98) Thus, food records allow for the most rigorous evaluation of the dietary habits of a study population. Angelique Perez (2007: 17) notes, “Traditionally, food records have been highly valued as tools for measuring dietary intake. They have been used to quantify and qualify dietary habits among myriad of different groups for a wide variety of research and educational purposes.”

Dufour and Teufel (1995: 10) define a food record as “a description of the food eaten and an estimate of quantity, recorded at the time of consumption. This record can be kept by an outside observer, or a literate member of the group can learn to keep food records.” This method offers several advantages. First, because behaviors are recorded during or shortly after consumption, this design fosters a degree of indemnity against recall bias. Furthermore, data collected in this manner is more accurately quantifiable, as estimates of weight or serving-size accompany records of food type ingested. From this quantified data, nutritional information can be inferred, such as net-calorie intake. “This can be done by comparing the total household requirement (sum of individual requirements) for energy or a given nutrient with an appropriate standard, such as FAO/WHO/UNU recommendations.” (1995: 10)

As with any study design, food records do present several limitations and potential draw-backs. Because the food record method is more tedious than food frequencies and food lists, the method can be much more time consuming and is contingent upon prolonged informant cooperation. Also, self-maintained food records may impel subjects to make dietary alterations and thus generate skewed data, “for example, by consuming less so as not to appear gluttonous or by limiting their use of certain foods, such as condiments, that are difficult to measure.” (1995:117)

Perez implemented a 3-day food diary among West Louisville middle school students. She explains her decision to use a 3-day rather than a 7-day design, stating “Nutrition researchers and health education professionals suggest that the food recording process lasts between 7 and 3 days. In the past, 7-day records were considered optimal. However, recent research suggests that reliability of food records can lessen with length of the recording process.”

A study conducted among Norwegian 9 year-olds (n = 100) to assess the validity of the food diary method shows this tendency. The study reported that “under reporters” in a 4-day food diary study “seemed to develop a study fatigue during the day and during the recording period. Increased awareness about the tendency of study fatigue can lead to more specific instructions on how participants can handle the problem.” (Lillegaard, et. al. 2007: 66) Dufour and Teufel suggest that duration should be indirectly proportionate to sample size to ensure representativeness. The larger the sample size, the less time is needed for evaluation, and vice-versa. (1995: 112 - 113) Furthermore, the diversity of the diet should be considered when determining the duration of the study.

If a wide variety of food-stuffs are commonly used, more time may be needed for all of the foods to be represented in the data, whereas if the diet is relatively homogenous, less time is needed to account for intra-group variation.

Related Studies and Relevance

Several undergraduate studies on student foodways at the University of Louisville have been conducted. (Udis 2006, Scherzinger 2002) The two studies cited here were all produced from research conducted in *Ethnographic Methods*, a course taught by Dr. Lisa Markowitz and offered through the Department of Anthropology at U of L.

Drawing on data collected from surveys and semi-structured interviews with U of L students, Alex Udis (2006) reports that “Resident students negatively associate living on campus in regards to their eating habits, while commuter students generally feel positive about living off campus.” He notes that price is a primary motive in resident students’ negotiations of what to eat because they feel compelled to exhaust their entire meal plan accounts. “Resident students feel powerless due to the sentiment that they need to spend all of the money on their meal card. They complain of having very few choices of a very limited variety on campus. They feel [that] the money on their meal plan, which is only good on campus, would be better spent at grocery stores, and are not in favor of the restricting mandatory meal plan.” (8)

Similarly, Ryan Scherzinger (2002) concludes that, for U of L students, time and money are the most pronounced factors influencing dietary behavior. He claims that cost restrictions on “healthier” food options lead many students to resort to cheaper “junk food” selections. His informants “expressed a sincere reluctance to spend cash on food since most perceive food bought with a meal card as free.”

Though an extensive nutritional assessment is beyond the scope of this study, we will use proximal nutritional indicators, such as frequency of fast-food consumption, in our analysis of self-reported food records. In a 1995 diet-record and food frequency survey study among college students, Hertzler, et. al. reported that students exhibiting the highest frequency of fast-food consumption also displayed approximately twice the level of fat intake as students who didn’t eat fast-food regularly. These researchers stated that “fast-food intake does not necessarily contribute a great amount of fat to the overall diet, but is predictive of a certain type of high-fat dietary pattern.”

In a 2007 article published in *The Chronicle of Higher Education*, Erin Strout reports that, “The American College Health Association estimates that three out of every 10 college students are overweight or obese. Both terms denote ranges of weight that are greater than what is considered healthy for a given height and have been shown to increase the likelihood of diseases.”



Current Food Services

All first-year resident students must buy a \$995 meal plan per semester. All others are automatically assigned a \$560 meal plan per semester. This spring semester is about 113 days. That works out to \$8.80 per day or \$2.93 per meal. To the right is a list of all businesses at which the meal-plan can be used, along with the hours of operation for each. This information was gathered directly from the Chartwells official website.

On Mondays through Thursdays almost all of these locations are open from 10am till 9pm. The exceptions are Mitzi's and the Terrace Food Court, which apparently cater to a lunch and breakfast crowd, and Tulip Tree Cafe which is open until 11:00 PM, serving hot sandwiches, some fresh fruits, and prepackaged salads. The weekends are much more restrictive. On Friday and Saturday nothing is open past 7pm. On Sundays, businesses resume their later evening hours.

Study Design

A 10-page packet comprised of a blank three-day food diary, a completed example diary-entry for one hypothetical day, a fifteen-question survey, instructions for completing and submitting the food diary and survey, and an informed consent preamble page were distributed to seven traditional dormitories on Belknap Campus. Residents of Miller Hall, Threlkheld Hall, Unitas Tower, Stevenson Hall, Louisville Hall, Community Park, and Kurz Hall comprised the study population. A total of 57 packets were distributed to each of these dorms, along with three flyers to be displayed in the dormitory lobby. As incentive to participate in the study, all respondents were entered in a \$100 cash prize drawing. On the final page of the packet, informants were provided with a space in which to record their email address if they wished to be entered into the drawing. The email addresses of respondents were then used to perform the random drawing, and to notify the winner. This email page was dissociated from each completed packet immediately after collection, and was not used to identify any respondent in relation to information reported in the food diaries and surveys.

Respondents were self-selected within the parameters of the larger resident population. Packets were made available at the front desk of each dorm, and advertised by flyers in a communal area to ensure that all residents had equal opportunity to participate in the study. Secure drop-boxes were placed in the lobby of each of the included dormitories.

Respondents were instructed to report only on designated days when completing the three-day food diary. This was to control for dietary variation throughout the week, in particular between weekdays, when students are assumed to spend more time on campus, and weekends, when students are assumed to spend more time off campus. We chose to use a three-day design because meta-analyses on the food-diary method indicate that the longer the duration of the study, the greater the threat of inaccurate reports as respondents lose interest or become fatigued.

Terrace Food Court (Student Activity Center)

Friday 7:30 AM - 2:30 PM (Breakfast & Lunch)

Saturday and Sunday Closed

Halftime Grill (Student Activity Center)

Monday through Friday 7:00 AM - 10:00 AM

(Power Breakfast)

Monday through Friday 11:00 AM - 2:30 PM (Lunch)

Monday through Sunday 5:00 PM - 9:00 PM (Dinner)

Saturday and Sunday 10:00 AM - 1:00 PM (Brunch)

Outtakes (Student Activity Center)

Monday through Thursday 7:30 AM - 11:00 PM

Friday 7:30 AM - 7:00 PM

Saturday and Sunday Noon - 6:00 PM

Subway (Student Activity Center)

Monday through Thursday 10:00 AM - 9:00 PM

Friday 10:00 AM - 3:00 PM

Saturday and Sunday Noon - 6:00 PM

Wendy's (Student Activity Center)

Monday through Thursday 10:00 AM - 9:00 PM

Friday 10:00 AM - 7:00 PM

Saturday and Sunday Noon - 6:00 PM

Papa John's (Student Activity Center)

Monday through Thursday 10:00 AM - 9:00 PM

Friday 10:00 AM - 7:00 PM

Saturday and Sunday Noon - 6:00 PM

Mitzi's (Miller Technology Building)

Monday through Friday 7:30AM - 3:00 PM

Saturday and Sunday Closed

Cardinal's Nest (University Towers Apartments)

Monday through Thursday 7:30 AM - 11:00 PM

Friday 7:30 AM - 7:00 PM

Saturday and Sunday 1:00 PM - 7:00 PM

Monday through Sunday 6:00 PM - 8:00 PM (Dinner)

Tulip Tree Café (Ekstrom Library)

Monday through Thursday 7:30AM - 11:00 PM

Friday 7:30AM - 6:00 PM

Saturday 9:00 AM - 6:00 PM

Sunday Noon - 10:00 PM



Respondents were to report only on days Sunday through Tuesday. We hoped that by including one weekend day and two weekdays, we would better approximate representativeness of the overall eating behaviors than if we focused only on weekdays or weekends. Also, we hypothesized that, due to more restricted hours of operation at on-campus eateries during weekends, residents are more likely to eat at off-campus locations on these days. This design was intended to allow us to corroborate or invalidate this assumption by comparing Sunday entries to Monday and Tuesday entries.

Results

We present quantitative results contained in our data set along with qualitative quotes from the participants to help explain the trends observed. Our data records the times that participants eat and the duration of their meals.

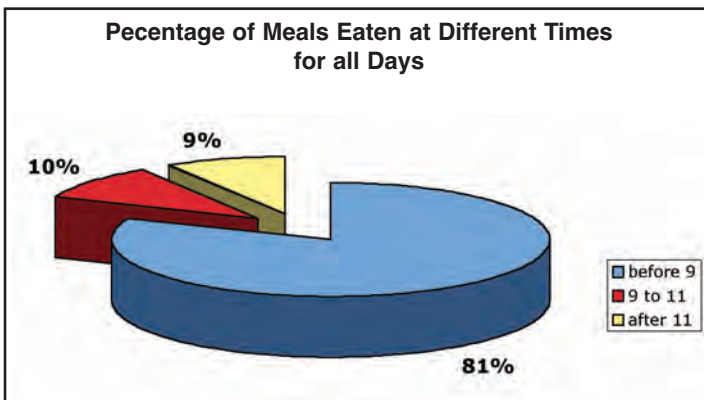

Here we were mainly concerned with how often people are eating after 9 pm, a time when hot meals are no longer available on campus. After 11pm no food of any kind is for sale. Indeed we found that 23% of the food students purchased off their meal plan (data not shown above) is purchased after nine. It should also be noted that if the data shown above is broken down by day we see the greatest amount eaten after nine is on Sundays. When we prompted the students to make their own, open-ended, suggestions for improving services, 15 of our 23 respondents suggested longer hours especially on weekends, and of those 7 suggested a 24 hour option, quote: "A 24 hour place for actual food (not just chips, etc.) would do really well. The reason students spend money OFF campus is that there is no option past 10-11 pm. If there was a place on campus students would be more likely to remain on campus over the weekend." We found that on average students eat 2.5 meals a week after 9pm and estimated that they would use a 24 hour restaurant 3.3 times per week. Also, 8.5% of our respondents said they would use a 24 hour restaurant on weekdays, 8.5% on weekends and the other 78% said both. Of course, we forgot to provide neither as an option but perhaps this answer is represented by the 4% who did not answer.

We also recorded the average time that people spend eating each day and depending on whether they ate on or off campus. The average off-campus times were 39, 37 and 25 minutes for

Sunday, Monday and Tuesday respectively, while the on campus times were 25, 26, and 36 minutes. We see a larger discrepancy on the weekends when people are more likely to eat for pleasure. If we consider longer meal times as indicative of eating for pleasure, it would seem that food services do not currently meet the needs of people wishing to take time to enjoy a meal. Indeed, this is a reflection of the fast food options for people on the meal plan and the fact that students tend to leave campus on the weekends which is in part because of the lack of food availability, as many students stated.

Eating Locations

The dominance of students eating in their dorm rooms may be an indication of the need for more inviting commons areas. One should also note the significant portion of the food that is procured off-campus, nearly 20%. Also 23% of the food eaten off-campus is eaten after nine. This leaves 77% of off-campus spending unaccounted for by a lack of open businesses on campus. It can in part be explained by the options for food itself, consider the results when we asked students where they ate their favorite meal:

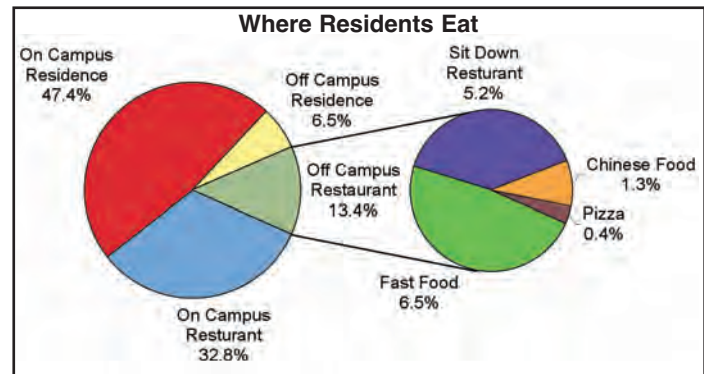

It would seem that students are really craving something resembling a home-cooked meal or a quality restaurant style dish. Furthermore, one should note some correlation of favorite meal with the places that people most often ate with others, a possible indication that students desire an inviting place to eat as a group. At the least the data above show that, should the University want to design its food services to foster campus community, it should model its menu's and dining areas to be more like sit-down restaurants and home-cooking. Another thing worth considering is whether or not students have access to a car. Those with a car did eat off-campus on average 2.7 times in three days as compared to 2 times for those without a car. This does not include Friday and Saturday. From the data, it is fairly clear about how students are making their food decisions.

So we see that taste is the dominant factor by far. This decreases slightly when we look at the reasons for choosing fast food, but the factor that gains is health. This can probably be explained by the prevalence of Subway as a choice and its image as being a healthier fast food option. This is evidence of a desire to eat more healthy on campus, but its failure to rank higher as a



Influencing Factor of Total 243 Entries

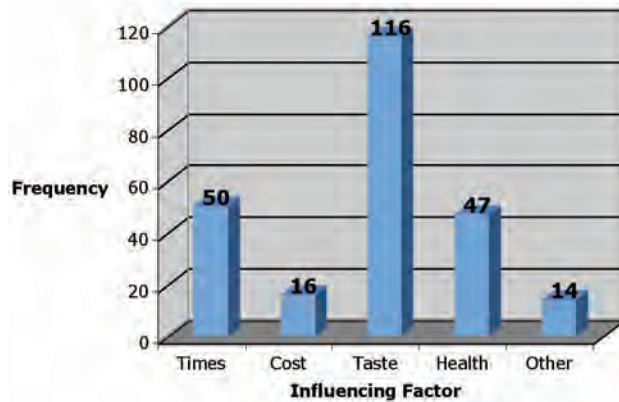

Reasons for Eating Fast Food

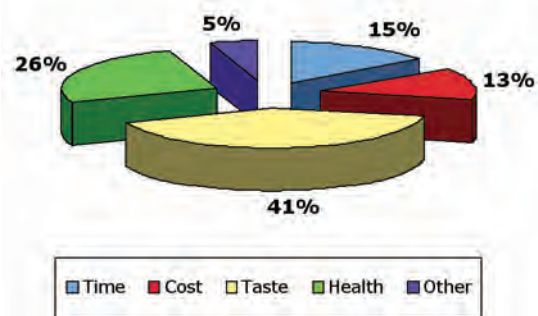

motive might be a reflection of the lack of healthy options. As one participant stated: “Half-time is borderline poison, as I’ve never eaten there without getting sick. Other than that I have only three basic options (Subway, Wendy’s, and Papa John’s) and none of these can really be considered healthy. I have gained over 30 pounds eating the same way as I did in high school with the only change being the type of food.”

We also sought to find out how well the amount of money on the meal plan matched the needs of the students.

For the most part it seems that students were able to spend all the money, but of course, they had to. The fact that students reported adding money to their meal plan would seem to indicate that the current amount is at least ample. Indeed, three students specifically requested that they be allowed to add money to their card as they need it instead of having to purchase a full meal plan in advance, and more complained of having to give up their money before services were rendered and remarked on the pressure to spend all the money. Some participants requested that deals be made with local restaurants so that they may accept meal cards. Even if this is not possible it should provide some insight as to how services should be changed in order to increase customer satisfaction.

Also among our interests was how local produce might best be integrated into the food supply. In their suggestions 7 of the 23 respondents specifically stated the need for more produce, especially vegetables and vegetarian dishes and complained about the freshness of produce currently offered. Food is fresher when grown locally and students might respond positively knowing their food is grown and picked mere hours away.

A final line of questioning was aimed at understanding the role that food-service has played in student’s decisions to remain on campus or move off.

It seems that those who chose to stay on campus found food-services were not too important in their decision, while for those moving off food service was much more likely to be “Very important.”

Recommendations

The University of Louisville is currently in the planning phase of a project involving the construction of several new facilities at Triangle Park, located on Fourth Street on the southern perimeter of Community Park. A prospective indoor/outdoor dining facility has been proposed as one element of this new site. We suggest that this new facility could provide an ideal environment for implementing several innovative amendments to current food services on campus, including later hours of operation, the introduction of food-preparation facilities for students’ personal use, a venue for food-preparation/nutrition demonstrations/classes, and a discrete setting for the integration of more locally produced foods into the university food system. These projected initiatives will be discussed individually.

Expanded Late-Night Hours of Operation

Our data indicate a significant trend of late-night eating among resident students. On average students ate 2.5 full meals a week after 9pm. In fact, 9 percent of all eating events happen after 11pm, and 19 % after nine. This is significant considering the limited options at these times. The only location on campus serving meals after 9:00 PM is the Tulip Tree Cafe, located in Ekstrom Library. Hot menu items are limited to pre-made panini that are grilled upon request.

Furthermore, 78 percent of participants reported that they would be inclined to use a 24-hour dining facility at least two times per week. Based on these findings, we recommend that the projected dining facility at Triangle Park offer later hours of operation, ideally remaining open until at least 2:00 AM, in order to accommodate this late-night eating trend observed among resident students. This would be particularly helpful on weekends, when current hours of operation are most restrictive, and when students are probably most likely to dine off campus, though we cannot draw this conclusion because our data was collected for only days Sunday through Tuesday.

In addition to better catering to the desires of resident students, this measure could prove very lucrative to Chartwells. By tapping into the late-night eater community, Chartwells could



Meal Plan Money Remaining

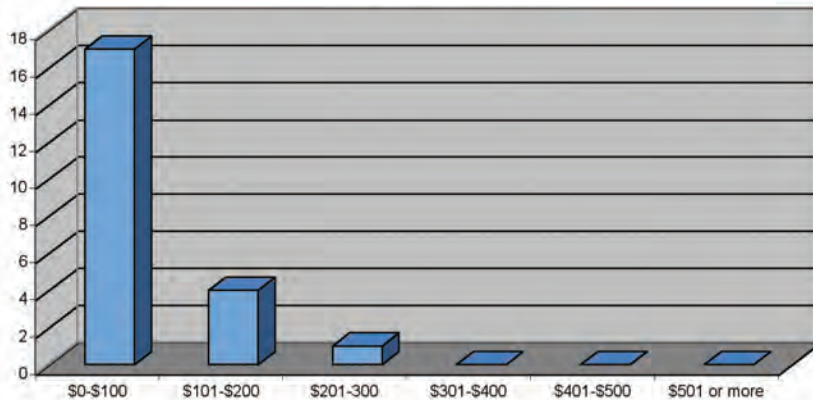

Importance of Food Service in Housing Decision

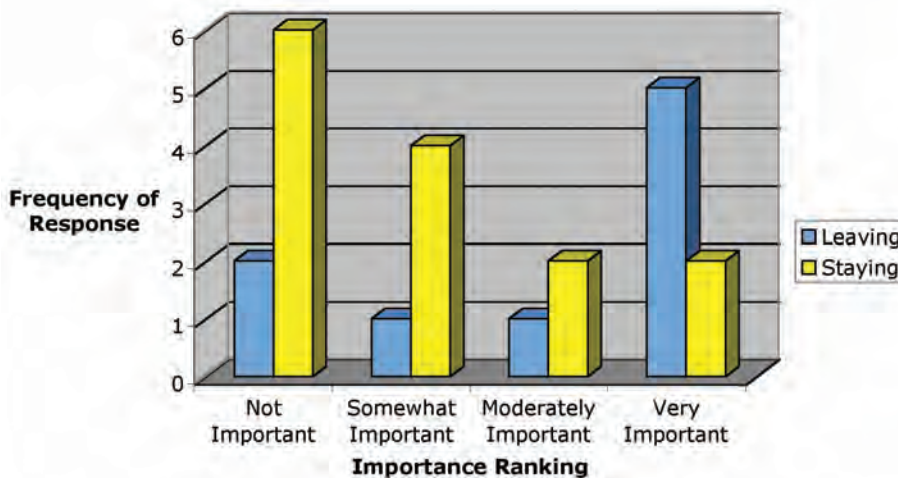

effectively increase their meal-plan holder market by attracting students who would normally be forced to find food options off campus during these hours.

Communal Cooking Facilities

In a 2006 study, Larson et. al. found a strong correlation between perceived skill level regarding, knowledge of, and frequency of food preparation with a significantly lower level of fast-food intake among young adults. The same study reports that young adults who regularly engage in food preparation are more likely to meet specific dietary recommendations as stated by the Food Pyramid, including number of servings of vegetables and fruits, whole grains, and protein. Finally, this study concluded that perceived lack of time was the most substantial barrier to food preparation behaviors among young adults.

Currently, resident students have access to communal kitchen facilities in each dorm. These usually consist of a stove/oven and cooking utensils (including pots, pans, flatware). Our study did not explicitly address the level of student satisfaction with available cooking facilities, nor the degree to which these facilities are

being used. Future research should examine these areas more thoroughly. However, our data shows that 54% of meals were eaten in on and off-campus residences. Though no significant portion of the meals described could conclusively be said to be prepared by the student, 6% of the meals eaten at off-campus residences appear to be home made and were often cited as favorite meals. The results certainly indicate a desire for home-cooked meals, if not a desire to learn to cook (though to some extent one requires the other). Furthermore, time was the second most frequently reported motive for food choice, suggesting that it is lack of knowledge and time that prevents students from cooking.

We believe that the expanded availability of cooking facilities could have decisive ramifications for resident student dietary behaviors and the fulfillment of nutritional requirements, while simultaneously providing an educational experience for students on food-preparation skills and techniques. Currently, all of Chartwells' internal operations, including Outtakes, Mitzi's, Half-time Grill, and Cardinal Cafe, are supplied with food that is prepared in a single central kitchen facility.

We propose that the new Triangle Park could offer cooking facilities for students' use. Our proposed design would involve open griddles or Hibachi-style grills along with smaller cooking utilities, like woks. Each cooking station would be supervised by a Chartwells employee in accordance with food-safety guidelines, and would offer fresh ingredients, including fresh produce and some meat, poultry, and egg products. Each student would have the freedom to choose what ingredients would be used in the preparation of dishes ranging from custom omelets to stir-fry. This would provide students with more agencies in deciding what they were consuming, while providing them with the life-long skills of simple and expedient food preparation. Furthermore, by providing students with fresh alternatives to heavily processed and fast-foods, this measure could help cultivate healthier dietary patterns among the student body.

Food Preparation Demonstrations

In conjunction with making food-preparation facilities available to students, the proposed Triangle Park dining facility could easily serve as a venue for food preparation demonstrations. In line with the aforementioned findings that young adults often report lack of time as the primary encumbrance to regularly engaging in food preparation, we recommend that local chefs and/or culinary students from Sullivan University, studying in



their final quarter, be encouraged to hold regular cooking demonstrations at the new facility, focusing on healthy but expedient recipes and cooking methods. This would provide all students with a fun and interactive educational experience without necessitating the addition of a cooking/nutrition course to the general education curriculum.

In a 2004 study on the efficacy of college cooking classes compared to cooking demonstrations, Levy and Auld report a higher rate of positive behavioral and knowledge-related gains for cooking classes than for simple demonstrations. We propose that the implementation of regularly scheduled cooking demonstrations that facilitated actual student interaction would be the most effective and viable design without having to introduce classroom-based courses requiring the involvement of university faculty.

Local Foods

In a 2005 article published in *Time Magazine*, Margot Roosevelt reports that, “Some 200 universities have jumped onto the eat-local haywagon—half of them since 2001, according to the Community Food Security Coalition, an advocacy group based in Venice, Calif. For many of these academic foodies, buying local is only part of an educational mission.”

Roosevelt describes how the University of Portland in Oregon has taken steps to increase the proportion of university foodstuffs purchased from local producers, including allocating a total 40 percent of the total food purchasing budget to buying from local producers. Administrators and students at the University of Portland have related these initiatives to environmental sustainability. Greater use of local foods can substantially cut down on food-miles, significantly decreasing the amount of fossil fuel expenditure generated by long-distance food transport. This reduces the carbon footprint of the food system, decreasing air pollution while mitigating Global Climate change caused by gas emissions. Also, small-scale local producers generally practice more sustainable agricultural

practices than intensive monoculture production methods, which require enormous amounts of chemical pesticides and fertilizers.

The socioeconomic benefits of local purchasing comprise another key incentive for establishing such farm-to-college programs. As the University of Louisville’s food services contractor, Chartwells is mandated by the state of Kentucky to allocate at least 10 percent of their total purchasing budget to locally produced foodstuffs. This initial quota alone will generate substantial revenue for local producers, simply by virtue of the large operating volume of Chartwells. In return the University’s food supply becomes somewhat insulated from rising gas prices.

How this local food will be integrated into the current system is not yet clear. We believe that this locally produced food should be at least partially segregated from conventionally produced foods within the larger food services system, for several reasons. First, we believe that if the locally produced food is integrated indiscriminately into the central kitchen food preparation scheme, it will be rendered indistinguishable from the conventionally-produced ingredients. If this were the case, students would not be able to make subjective assessments of differential quality levels between local and conventional foods. We predict that students will show strong preference for fresh locally-produced foods if given the opportunity to try these products.

If local foods are segregated from conventionally produced foods, it will better facilitate future market analyses on consumer preference regarding local foods. If a strong preference for locally produced foods can be demonstrated by such analyses, it would provide greater incentive for Chartwells to integrate even more local food into the food services system. Roosevelt (2005), Biemiller (2005), and Fleming (2004) all report higher preference for locally produced foods on campuses where such products have been made available, including Dartmouth, Middlebury College and Sterling College

in Vermont. We hope that the initial 10 percent quota will only be a first step towards purchasing greater proportions of food products from Kentucky producers.

Eventually, we would like to see the establishment of a weekly farmers’ market at the new Triangle Park facility. The proposed indoor/outdoor layout of the new dining facility would be an ideal setting for such a project. Erin Strout reported in 2005 that “Last year [Texas A&M] started holding a farmers’ market every Thursday on the campus. At first just a few people showed up, but now hundreds of students and staff and faculty members line up every week.”

Because locally produced foods often cost more than conventionally produced foods purchased from bulk distributors, Texas A&M officials reduced portion-sizes to counterbalance these price premiums. Regarding price premiums of locally produced foods, Fleming (2004) reports, “In successful projects, Ms. Markley says, local foods usually account for only about 5 percent to 10 percent of the overall food budget. At large state institutions, that figure may drop to 1 percent or 2 percent.”

Biemiller reports that (2005), in some cases, buying local can result in reduced costs by cutting down on food-waste and spoilage. We believe that a farmers’ market could easily be made compatible with the meal-plan system by allowing students to allocate a certain amount of their total meal-plan fund for market vouchers. The farmers could then be paid up front for the products purchased by voucher holders. Similar operations have already been undertaken by small farmers associated with the Community Farm Alliance as they have gained the ability to accept food stamps. This would stabilize the market for participating farmers, allowing them to lower their risk.

Future Analyses

Our final recommendation is that a modified, slightly more rigorous version of this food-diary study design be implemented as a final assignment in the existing general education requirement curriculum as part of the class that all Arts



and Sciences freshman take to familiarize themselves with the campus and University Life. Due to the very low response rate that we experienced, the data generated from our study does not allow for a high confidence interval, and thus conclusive generalizations cannot be made. Furthermore, because of the self-selective nature of our sampling technique, data may be heavily biased, and cannot be regarded as representative of the entire resident student population. By assigning this study to all students enrolled in general education, these confounders can be controlled for, and representativeness can be easily achieved. The data generated from such an analytical tool in conjunction with the aforementioned recommendations would be extremely helpful to future evaluations of the efficacy of these measures. Furthermore, if the University is concerned for the health of students, which can be easily linked to academic performance, then it would do well to be sure that students are nutritionally literate and well aware of their own eating habits. Participation in a food-diary would help to reach this goal. _____

References

- Biemiller, Lawrence. 2005 Fresh from the Farm. *Chronicle of Higher Education*, Vol. 52 Issue 14: A36-A38.
- Chartwells, Inc. Website. <http://www.dineoncampus.com/louisville>
- Fleming, Brenda. 2004 Not Their Father's Dorm Food. *Chronicle of Higher Education*, Vol. 51 Issue 5: A6 - A6, 1/2p.
- Goral, Tim. 2003 Serving Up Success. *University Business*, Vol. 6 Issue 11: 52-56.
- Hertzler, A. et. al. 1995 Over Consumption of Fat by College Students - The Fast-Food Connection. *Ecology of Food and Nutrition*, Vol. 34 Issue 1: 49-57
- June, Audrey. 2006 A Menu for Change. *Chronicle of Higher Education*, Vol. 52 Issue 33, A34-A36.
- Larson, N. et. al. 2004 Food Preparation by Young Adults is Associated with Better Diet Quality. *Journal of the American Dietetic Association*, Vol. 106 Issue 12: 2001-2007
- Levy J, Auld G. 2004 Cooking Classes Outperform Cooking Demonstrations for College Sophomores. *Journal of Nutritional Education and Behavior*, Vol. 36 Issue 4: 197-203.
- Moran, Emilio F. (ed.) 1995 *The Comparative Analysis of Human Societies: toward common standards for data collection and reporting*. Boulder, Colo.: L. Rienner Publishers.
- Pelto, G.; Pelto P. 1989 *Research Methods in Nutritional Anthropology*. The United Nations University.
- Perez, Angelique. 2007 Food Diary Project, Master's Thesis
- Roosevelt, Margot. 2005 What's Cooking on Campus. *Time*, Vol. 166 Issue 20: 61-62
- Scherzinger, Ryan. 2002 Eating Behaviors on a College Campus in Louisville, KY. Undergraduate research, *Ethnographic Methods*
- Strout, Erin. 2007 Obesity Comes to Campus. *Chronicle of Higher Education*, Vol. 54 Issue 4: A1-A26
- Udis, Alex. 2006 Belly. undergraduate research, *Ethnographic Methods*

Creating Sustainable Outdoor Education Programs

Melissa Cottrell, Jennifer Hambley,
Lindsey Joyce



Creating Sustainable Outdoor Education Programs

Using data collected from two different studies performed in California—*Effects of Outdoor Education Programs for Children in California* by American Institutes for Research and *California Student Assessment Project and The Effects of Environment-based Education on Student Achievement* by State Education and Environmental Roundtable (SEER)—it has been shown that outdoor classrooms can provide numerous benefits to students and teachers.

In the (SEER) study, the participating schools were divided into two groups—a control group and a treatment group. In some cases, the treatment group and the control group were classes of students from the same school. The control groups in this study used a traditional educational framework. The treatment groups used the school's surroundings to teach the students environmental awareness. In pairing the control schools and the treatment schools, measures were taken to insure that the teachers were matched to the best possible measure based on years teaching, grade level, and subject area taught (Lieberman, 2). Measures of evaluation included standardized test results, attendance rates, and grade-point averages (Lieberman, 2). The overall findings stated: (1) Better performance on standardized measures of academic achievement in multiple disciplines, (2) Reduced classroom management and discipline problems, (3) More enthusiasm about learning from the students involved, and (4) increased sense of ownership in student accomplishments. In most cases, the treatment groups scored significantly higher in the majority of the areas measured by the study.

The second study was performed by American Institutes for Research in 2004 (completed in 2005), and focused on at-risk sixth graders. 255 students were divided into two groups (within the same school). The treatment group was allowed to use the outdoor classrooms. The control group was allowed to attend the outdoor classrooms once the study was complete so that the children were not deprived of the opportunity to visit them. Parents and teachers were also involved in this study, and all three groups were surveyed at different points. The research team also conducted site visits. The study found that the treatment group had higher gains in conflict resolution and showed more concern with

conservation after participation in the outdoor classroom programs. The outdoor classrooms also helped students raise science test scores by approximately 27 percent (American Institutes for Research, vi).

These results are similar to those from the (SEER) study. In Washington state, Oksana Bartosh reported the results of the Pacific Education Institutes Environmental Education Assessment project. This project compared 77 pairs of schools to assess the effects outdoor education had on students GPA, test scores, attendance records, and community involvement. Schools that implemented EE programs were repeatedly reported as having higher state test scores than schools with more traditional programs (Bartosh, 126), and schools with EE programs had a higher rate of parent and community involvement. Even schools with only 20-25% of teachers involved in these programs showed higher standardized test scores (Duffin, 1).

In Florida, four hundred high school students were included in a study that compared Environmental Education classrooms with traditional classrooms. This study, controlled for GPA, gender, and ethnicity, recorded significantly higher student test scores on the Cornell Critical Thinking Test for both grade levels. Teacher interviews indicated that the Environmental Education programs influenced students' critical thinking skills due to the interdisciplinary nature of them. They force students to think outside the box and draw conclusions and comparisons between observations and classroom-based knowledge (Athman).

An additional study was conducted in South Carolina. Within the first year of the implementation of an outdoor education program, all 10 middle schools participating in the study showed improvement in the areas of attendance, behavior, and academic achievement (Falco, 6-8). Research continues to emerge supporting the idea that outdoor education and environmental education have the potential to provide teachers with a method for improving the retention rates of students and to raise the level of interest in learning. One problem, however, is sustaining these outdoor classrooms long enough to reap the benefits of them. A large majority of outdoor education programs have trouble continuing to operate after the initial startup period.



Previous Research

Wild School Sites states that the success of outdoor classroom projects depends on:

- The location and natural history of the site
- How much work and time is required to make the project happen
- Scale of the project
- Available resources
- Cost
- Neighboring land characteristics
- Realistic capacity to make changes in the environment
- Provisions for long term sustainability of the habitat
- School and community support

(Wild School Sites, 14)

A Guide to Planning and Development of Outdoor Classrooms offers a different set of sustainability factors to consider when creating an outdoor classroom. It maintains that the more people committed to the project, the greater the likelihood of success. It stresses that once school administration has confirmed support for the initial planning of the outdoor classroom program a committee should be formed to oversee the planning and development. Ideally this committee would be made up of teachers, administrators, board members, parents, custodians, students, and resource specialists. It stresses the importance of keeping custodians and maintenance staff involved in the project. Often custodians take pride in being part of such a project and grounds maintenance personnel must be familiarized with the master plan for the space so they can avoid seedlings and sections of the project being mowed down by mistake. The guide also emphasizes the involvement of student organizations such as Scout groups, FFA chapters, and 4-H groups as well as Environmental groups around the community. Local Media coverage should be encouraged as this can increase community involvement and allows students, teachers, and volunteers to show what they have accomplished.

Schoolyard-Enhanced Learning cites two specific issues that encourage longevity in outdoor classrooms: projects should start small and they must be more than one person's dream. Projects that start out too big tend to burn out the participants. Goals appear unattainable or unrealistic. Projects that remain the efforts of one person are doomed to failure over time as teachers move, retire, or simply tire out.

Georgia Wildlife Federation Study

A large comprehensive study was conducted in 2004 by The Urban Conservation and Education Initiative (UCEI) focused on identifying common pitfalls that have led to the discontinuation of outdoor classrooms in Georgia. The Urban Conservation Education Initiative worked as a sub-group of the Georgia Wildlife Federation (GWF) with funding from Georgia Power,

Southern Company, U.S. Fish & Wildlife Service, and National Fish & Wildlife Service (Georgia School Wildlife Habitat Planning Guide, 2). The GWF had established that there were nearly 2000 records of outdoor classroom projects in Georgia between the years 1989 and 2003. However, follow-up inquiries established that 41% of those classrooms were no longer in use and 84% of those were abandoned by their second year. In contrast, programs that were still in use had been established for an average of eight years. This prompted the GWF to launch an initiative under UCEI that included surveys of teachers, parents, community volunteers, students, environmental education organizations, school maintenance staff, and public land managers. They then hosted the "Schoolyard Ecology & Greenspace Symposium" on September 10, 2004 to share findings and get input from experienced and interested participants (Best Management Practices, Ch. 1). This data was then drawn up to create a comprehensive guide to creating, maintaining, and sustaining outdoor classrooms under the name of *Best Management Practices: Planning First to Make Your Outdoor Classroom Last*. Findings were also included in the *Georgia Schoolyard Wildlife Habitat Planning Guide*. These findings include the top five reasons for failure and success listed below:

Reasons for failure: (in order of frequency mentioned)

1. Continued maintenance and upkeep
2. Teachers unsure and unable to incorporate usage into lessons
3. Inadequate funding
4. Vandalism (especially at high schools)
5. School expansion or relocation

Reasons for Success

1. Community support
2. Student involvement
3. Funding
4. Teacher training
5. Administrative support

(*Georgia Schoolyard Wildlife Planning Guide*, 2)

The number one concern on both lists was not the financial aspects of the project, but the willingness of people to work to maintain the project. In addition to a step by step guide to creating an outdoor classroom that lasts, the *Best Management Practices* guide offers a chapter devoted to "Institutionalizing Use & Maintenance of Your Outdoor Classroom" and another on "Evaluating the Success of Your Outdoor Classrooms" both in terms of academic success and site sustainability. The former contains suggestions such as rotating leadership responsibility and delegating small tasks to different people. It stresses the importance of being aware of what the teachers and administrators need or want from this project before work is even begun. It further emphasizes the need to make sure teachers are comfortable using outdoor classrooms and encourages regular training sessions. It encourages a multi-disciplinary use of the outdoor



classroom and says to avoid relegating the outdoor classroom to just one subject. It also maintains that student and community involvement is essential for a long lasting program and offers suggestions on how to make volunteering fun and easy. However, it states that the most important thing to do is create an easily accessible maintenance guide for the outdoor classroom so future outdoor classroom leaders and volunteers will know how and when to perform maintenance tasks and suggests the guide should be updated frequently. This is important because often, due to lack of record keeping, staff members would initiate projects to create an outdoor classroom without any knowledge of former programs that were once active at their school. Therefore, instead of being able to work from what was left behind, they start from scratch. Such problems could be avoided if better records were kept (Kail,1) .

The chapter, "Evaluating the Success of Your Classrooms" discusses keeping a log of activities conducted and keeping track of data that would indicate any change in academic performance. It also focuses on the need to check annually for repairs or improvements that might be made and reminds the reader that changes will happen over time and that the ability to remain flexible is necessary. It stresses that the most important factor is the ability of teachers to comfortably use the outdoor classroom. Continued training and resources should be emphasized before enlargement of the project is considered. The *Georgia Schoolyard Wildlife Habitat Planning Guide* is essentially an updated and reorganized version of the *Best Management Practices* guide.

The *Georgia Schoolyard Wildlife Habitat Planning Guide* also offers a number of case studies from schools that attended the 2004 Symposium. Schools listed 2005 accomplishments, Best Management Practices Incorporated, and Difficulties Encountered. Mt. Yonah Elementary in White County, Georgia noted that their school developed a master plan for 6 different garden areas and used specialists in the field to help create these gardens. They cited as a difficulty "incredibly poor soil quality. The school contacted the local county extension office to help break up soil since the school is new and the surrounding area had been used as a construction refuse site." East Jackson Middle School constructed and installed 10 bluebird houses in 2005. However they ran into issues when the "call before you dig" staff did not show up before their first designated work day. The issue was resolved when they contacted the county technology director and maintenance supervisor who gave them permission to dig. For a complete list of case studies see *Georgia Schoolyard Wildlife Habitat Planning Guide* page 60.

In addition to these two guides, Amanda Kail, the Education Program Coordinator for GWF published an article called "Sustaining Outdoor Classrooms" in *Green Teacher* magazine. This article suggests additional ideas to making an outdoor classroom last. Kail stresses that "the abandonment of any outdoor classroom represents a considerable waste of money, human energy, and educational potential." She notes that schools are "dynamic by nature" and therefore steps must be undertaken if outdoor classroom programs are to be sustained. She notes that it is imper-

ative that outdoor classrooms be "designed so that their use is easily integrated into pre-existing curricula" and that emphasis should be given to creating "outdoor classrooms that are easy to maintain". She echoes points made by Lottie Gwaltney in 1951 when she notes that too often outdoor classrooms are thought of as "extras - extraneous projects that serve only to beautify a campus." She ends by calling for increased recordkeeping and asks teachers to "think of outdoor classrooms as long-term, constantly evolving projects."

Georgia has a long history in outdoor education. Atlanta, Georgia is cited in *A History of School Gardens in Louisville, Kentucky* as a national model in 1951. This study is set at the beginning of the creation of environmental education as we know it today but many of the suggestions made by the author, Lottie Gwaltney, are similar to current recommendations. One additional idea she mentions is that a probable cause for the uneven development of outdoor classrooms throughout the nation is that rural school children already have exposure to the environment and often are maintaining gardens of their own at home. For this reason they are less likely to be excited about outdoor involvement. Gwaltney notes that attempts to operate gardens far away from individual schools were abandoned due to the expense of getting the students to and from the garden. She listed as her number one recommendation "more publicity and promotion activities" and as the top weakness of school garden programs in Louisville "lack of organization as a curriculum experience."

Watershed Learning Program-A Community Initiative

The Watershed Learning Program offers a slightly different perspective to the field of outdoor classrooms. The Watershed Learning Center (WLC) was created by the Brandywine Valley Association (BVA) in West Chester Pennsylvania to provide environmental lessons for schools. BVA instructors worked one-on-one with teachers to guide them in the creation of outdoor classrooms and implementation of lesson plans. The idea behind this organization is that if teachers are given pre-packaged lesson plans that meet state-mandated environmental standards, and are then walked through the process with BVA staff they will be much more confident and more likely to use the outdoor classroom.

BVA then received additional funding to create follow up studies to measure the effectiveness of the WLC program and develop a model program that can then be used by other watershed associations to implement similar programs in their communities. Some key factors to the success of the Watershed Learning Program can be found below:

- Adoption of program was teacher driven
- Teachers enthusiastically accepted the program because it was introduced as a supplement to existing curriculum not a prepackaged program teachers were mandated to adopt.
 - Voluntary participation and ability to customize designs.



- Content customized to fit state EE standards and school curriculum, and to fit the characteristics and issues of the local environment
- brief introduction by sample lesson demonstration were followed by smaller grade level planning sessions
- Grade-level review sessions provided feedback, modification and planning ideas
- Regular meetings with WLC staff to discuss program progress and make program-wide decisions
- Consistent and clear communication between WLC staff and school staff.

(Kenney, 2-5)

The two difficulties cited by the Watershed Program suggest that obstacles can be similar regardless of how the outdoor classroom program is initiated. These difficulties were staff changes and school reorganization.

Many of the difficulties faced by outdoor classrooms are already documented and the purpose of this study is to identify which of these factors are most relevant to the outdoor classroom programs in the Louisville Jefferson County Public Schools system.

Outdoor Classrooms in Louisville

There are 53 schools listed on the Brightside website as having an outdoor classroom of some kind. It is estimated that there are approximately 70 schools in which at least one teacher uses the outdoors as a teaching site (Brightside), but no comprehensive list exists. In addition to school specific outdoor classrooms, JCPS also offers a variety of outdoor education experiences through local partners such as Blackacre State Nature Preserve, Jefferson County Memorial Forest, The Falls of the Ohio, and Bernheim Forest. The Environmental Education Committee and Outdoor Classroom Committee of the Partnership for a Green City are also devoted to providing and improving outdoor education experiences for students within JCPS.

According to The Operation Brightside web site, JCPS outdoor classrooms can be divided into three categories, including biomes, gardens, and eco-theatres. The biomes classroom is available at the Kennedy Montessori School and involves the simulation of desert, prairie, and wetland biomes that use only plants native to the region. In addition to the use of native plants, the Kennedy school also has a Tree Nursery.

Garden classrooms make up the overall largest percentage of total outdoor classrooms. These can include butterfly and hummingbird gardens, Kentucky crop gardens, pioneer gardens, shade gardens, native plant areas, and bog gardens. Common features of these gardens include bird feeders and houses (some of which the students are involved in building), small animal shelters, fish and turtle ponds, and herb and wildflower areas. In at

least one instance, students are involved in the entire process of planting including seed propagation and transplanting, as well as the maintenance of the bed over the course of the growing season.

The eco-theatre programs consist of theatre seating surrounding a classroom learning area. This may include a planting bed platform or a bog habitat in development.

Other common features that are found in the outdoor classroom and environmental education curriculum are nature trails and preserves, recycling and litter programs, water testing programs, weather station monitoring, wetland and aquatic organism management, and the use of greenhouses. Several of the outdoor classrooms for schools listed include more than one of these features and involve the students in the process of learning how these factors fit together and depend on one another.

According to the EPA website, JCPS has received grants to build outdoor classrooms since 1993. At least two of these grants specified Lassiter Middle School as the recipient of the award. The program at Lassiter has been struggling to get off the ground. According to the EPA website the first grant to Lassiter for use in its outdoor classroom project was awarded in 1993. These programs also find funding through other groups and organizations that aim at connecting children to the environment, such as The National Wildlife Federation and local groups such as The Fund for the Arts (through the Alcoa Foundation).

Our study was designed to find out why it is that some of these programs fail or struggle to get off of the ground, while other school's programs succeed. Still other outdoor classrooms succeed for several years and then slowly decline in structure and impact. The primary question our research tried to answer is "What are the main components that lead to success and sustainability once a program is established?"

Methods

In conducting research regarding outdoor education programs, there were two main goals: (1) to compile a comprehensive list of all Jefferson County Public Schools (JCPS) with existing outdoor education programs and (2) to determine those factors contributing to the success or decline of outdoor education programs. Two surveys were administered to obtain this information.

Design and Procedure

In order to compose a comprehensive list of JCPS schools with outdoor education programs, a short survey was sent to all 153 JCPS school principals listed on the JCPS website.

1. Name of school
2. Did your school have any type of outdoor education program this school year? This includes any teacher that



used the outdoors as a tool for teaching, even if they only did it once.

3. Please list the contact names and email addresses of any teachers who were involved in the use of the outdoor education program this year.
4. Any comments about the use of outdoor education at your school.

From this survey and the contact list provided by Brightside, a list of teachers involved with environmental education programs throughout JCPS was compiled. This list consisted of 89 contacts from various schools in Jefferson County.

The contacts provided by the principals in the first survey were then sent a different survey regarding the use of the outdoor education programs at their specific school. This survey was available in paper form or online and consisted of five closed response questions and two open response questions. The first question asked if the school provided an outdoor education experience for the students? The second question regarded the longevity of the program. The third question asked how many teachers within the school used the outdoor education program? The fourth question asked how often the program was used? In the fifth question, the participant was asked to rate various factors based on the level of difficult in maintaining an outdoor education program. The last two questions allowed the respondent to add any additional difficulties that have been faced but overlooked by the survey and to describe the school's specific outdoor education program.

Results and Discussion

The principal survey was used to compile a list of teachers and school personnel involved in the outdoor education programs. Surveys were sent to all 153 JCPS principals but only 32 were returned. From these surveys and the list provided by Brightside, a list of 89 contacts was created. Twenty-three principals said their school does have an outdoor education program while the remaining 9 do not have programs.

As previously stated, this list was used to determine the recipients of the second survey. However, using the contacts provided created a bias in the second survey towards those schools having an outdoor education program. Most of the principals who responded to the first survey were from schools that had some type of outdoor education program. If a principal responded that his school did not have an outdoor education program, he did not list any contacts for the second survey and the school was not involved in the second portion of the study.

The results from the second survey were more detailed and quantitative than the results of the first survey. Of the teachers that responded, 65% said that the school provided an outdoor experience for the students. Surprisingly, 48% of the programs have existed for five or more years. Twenty percent of the responses answered that the program was in its first year of existence. The

overall results for program existence can be seen in the chart below.

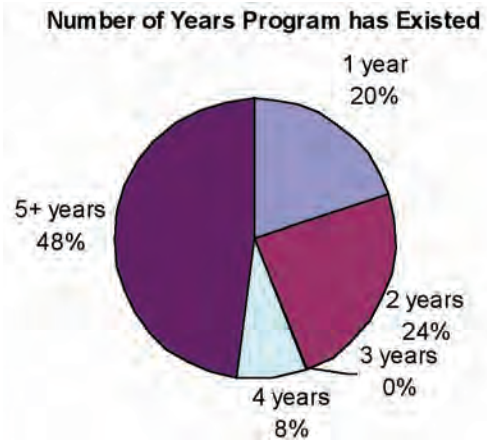

In 74% of the programs, five or more teachers use the outdoor education program at some point during the year. This included any teacher that used the outdoors at least once during the school year as a tool for teaching.

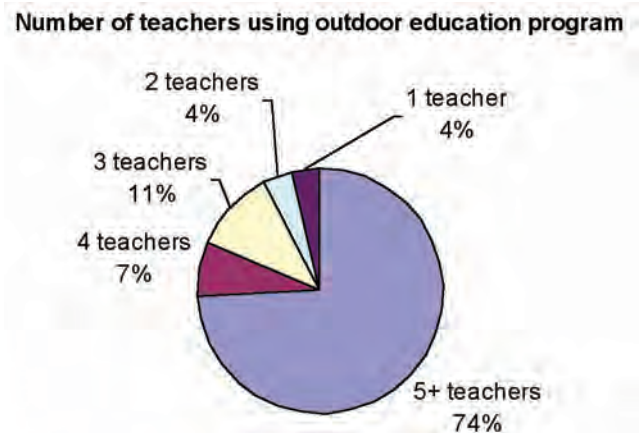

The third question in the teacher survey asked how often the respondent's class used the outdoors for learning. This question asked specifically for the number of hours per month the classes used the outdoors. Only 10% of the teachers use the outdoors 16 or more hours per month on average. About 61% of the teachers use the outdoors less than 5 hours per month.

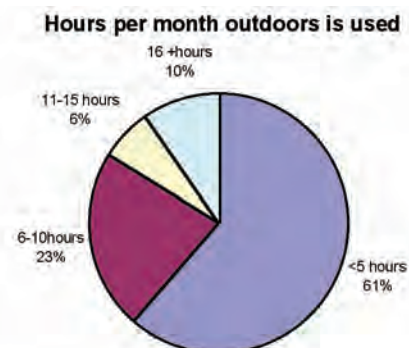



The respondents were asked to rate a variety of factors in terms of the level of difficulty the school has faced in maintaining the outdoor education program. The factors were ones listed in a previous study as being some of the major factors that contribute to the failure of outdoor education programs. The first factor rated was continued maintenance and upkeep. This included summer upkeep. Fifty-six percent of programs experienced difficulties in the area of continued maintenance and upkeep. Only 14% said that this was a great difficulty for the program.

Continued Maintenance and Upkeep

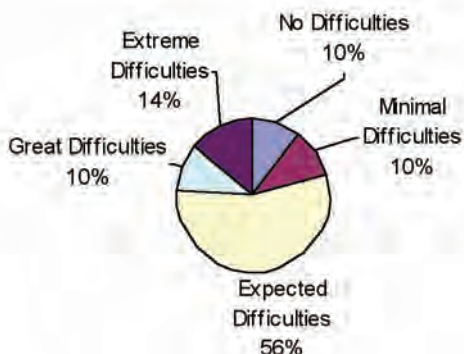

The second factor was the difficulty in incorporating outdoor education into the core curriculum required by the JCPSS school board. Most programs experienced minimal difficulties in this area. None of the respondents experienced extreme difficulties in incorporating outdoor experiences into the required curriculum.

Incorporation into Core Curriculum

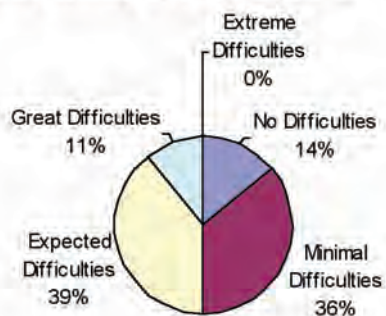

The third factor rated was the difficulty of obtaining the funds to maintain an outdoor education program. As expected, funding was a major problem. On average, funding was rated as being the most difficult problem in maintaining the programs. Approximately 49% experienced difficulty with funding. Funding was an extreme difficulty for only 3% of the programs and was of no difficulty for 7% of the programs.

Funding



Vandalism is another factor that often contributes to the failure of outdoor education programs. Vandalism is a factor that will vary with the location of the school but is still important to all outdoor education programs. Fifty-two percent of the programs experienced less difficulty than expected concerning the amount of vandalism to the program facility. Vandalism was an extreme difficulty in 4% of the cases examined.

Vandalism

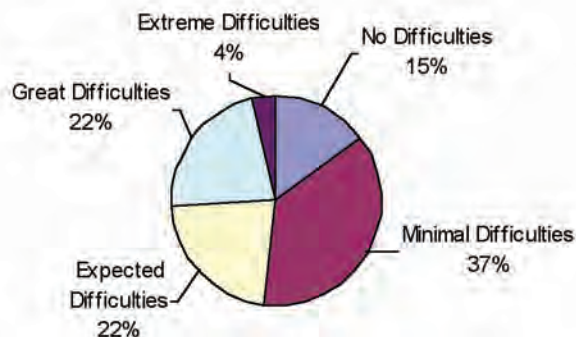

Administrative support was the area of least difficulty in maintaining outdoor education programs. Fifty-seven percent of respondents experienced no difficulties in obtaining support from administration.

Administrative Support





Receiving support from other faculty members was also not difficult. Only 4% of the cases experienced extreme difficulties in this area. Nearly 75% experienced less difficulty in expected in obtaining support from other faculty members.

Support from other Faculty Members

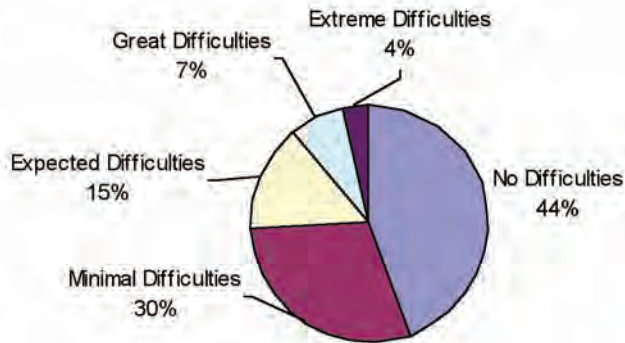

Involvement from parents and the other community members was also thought to be a possible source of difficulty. Sixty-three percent of respondents said that parental involvement was at a level of expected difficulty or below. In 33% of the programs, parental involvement is a difficult area. Four percent of the programs find it extremely difficult to get the parents involved in maintaining the outdoor education program.

Parental Involvement

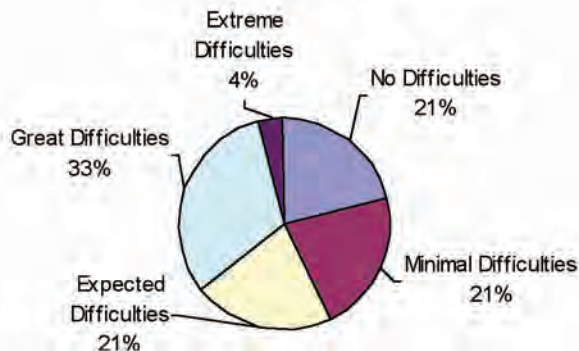

Community involvement is even less of a contributing factor. Seventy-eight percent of study participants experienced no difficulties to an expected level of difficulty in the area of community involvement and maintaining the outdoor education program. Once again, 4% found this to be an extreme difficulty.

Community Involvement

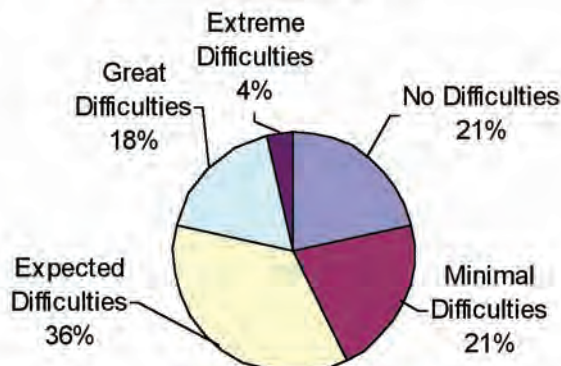

By looking at the average rating for each factor, funding is the area with the highest level of difficulty experienced in maintaining outdoor programs. This is followed closely by continued maintenance and upkeep caused by the fact that teachers and students are not present on the school grounds during these months.

Teachers were also asked to list any other difficulties they have faced in maintaining outdoor education programs. These included: lack of time, summer upkeep, finding coverage for the remaining students when going off campus, weather, equipment malfunctions, communication and support from JCPS Board of Education, and relationships with JCPS grounds crew.

It was also determined that many different types of outdoor education programs exist. The descriptions from the teachers varied and included gardens, wetlands, and use of off-campus facilities for outdoor education. Below is a complete list of outdoor education program types:

- Trees
- Bernheim Forest
- Vegetable and flower gardens
- Butterfly gardens
- Wooded areas
- Beargrass Creek
- Nature lodges
- Red River Gorge
- Hiking trails
- Environmental club (planting, clean up, recycling)
- Blackacre
- Wetlands
- Natural grasses (prairie)
- Historical garden (dedicated to historical figures)
- Native plants garden
- Jefferson Memorial Forest
- Greenhouses
- Fish ponds
- Animal ecosystems/habitats

Recommendations

According to the goals set in 2004 by the Partnership for a Green City, all schools within the JCPS system should have access to outdoor classrooms by the year 2009. In addition to this, all students should have the opportunity to experience out-of-classroom learning and teachers will be trained in the use of the tools and curricula needed to assist their students in that learning experience. These curricula will reflect core content and will be consistent with learning levels and expectations. Resources from all partners of the Green City program will be readily available and easily accessible to schools and teachers within the school system. The criteria for evaluation will be set and defined so that the teachers will be able to identify what is expected of these programs. The set of evaluations will provide an outline to help implement successful programs.

Our research has reflected that as of the 2007-2008 school year, many of these goals continue to be undeveloped and unrealized.



According to the website for a Partnership for a Green City the Louisville/Metro Parks department has 122 parks that cover more than 13,500 acres. In addition to this, the city has more than 850 vacant lots that can be used as outdoor classrooms. Many regional classrooms are also available including: Blackacre State Nature Preserve, Jefferson County Memorial Forest, Falls of the Ohio State Park, and Bernheim Forest.

Our first recommendation calls for the development and maintenance of a concrete, streamlined framework for Environmental Education within the JCPS system. This framework is essential to the successful development of outdoor classroom opportunities in every school within the system. It would provide relief and support for overburdened teachers who are in any stage of development of their outdoor programs. It would greatly benefit teachers who wish to establish programs or reinvent existing or unsuccessful programs to have an efficient process to guide them as they navigate a web of contacts, criteria, funding grant proposals, and curricula. It would also be to the advantage of all concerned to have contact people for certain sets of problems encountered during the different stages of implementation.

Many teachers do not understand the goals of Environmental Education and are unaware of the resources that are available to them through various partners and programs. We recommend the delivery of Environmental Education possibilities to all teachers within the JCPS system. This could be accomplished by first providing basic information to teachers at mandatory teacher in-service meetings at the start of the school year. If the teachers wish to pursue an Environmental Education approach they should then have the option to attend workshops dedicated solely to Environmental Education goals, procedures, and opportunities. These should also be conducted during in-service hours.

We have been made aware through informal interviews about the availability of a Mobile Outdoor Classroom Unit provided by Bernheim Forest. The possibilities for a program like this are numerous and the resource itself seems to be underused. This program can provide an example to teachers and students of what they can do at their school as well as excite and motivate them to help with the establishment of an outdoor program at their school. A Mobile Outdoor Classroom can also provide the outdoor education experience to students whose schools do not have the funds or grounds for a program at this time or are in the early stages of development.

As stated in the analysis section above, summer upkeep of outdoor classrooms is a big problem faced by many schools. The problems include weeding and watering plants during the vacant summer days, vandalism, and the destruction of beds by grounds crews who are often unaware of their existence. We recommend

expansion of the E-CORPS program, which employs students who are earning their GED in development and restoration programs throughout the city. This growth of E-CORPS employees can be used to provide additional care for established outdoor programs and possibly help with establishing new ones.

In developing a more streamlined framework for Environmental Education throughout the system, we recommend the inclusion of a trouble-shooting network for teachers to address specific problems they encounter that involve JCPS administration, maintenance, and grounds crews. This network should, at the least, provide all teachers using Environmental Education with a list of contact people within each department who are specifically assigned to deal with particular problems pertaining to their department. For example a supervisor for the grounds crews who is informed about existing outdoor classrooms can then inform his crews on areas not to mow. This same contact would be the person a teacher can call if there is a problem. Teachers should also have a specific person to contact for help with grant or funding problems, curriculum problems, and guideline issues so that they can remain within the goals set for the Environmental Education programs.

We would also recommend a campaign to inform teachers and students of the benefits and resources available through the implementation of Environmental Education. This can include posters, mass emails, and pamphlets. A list of other options for outdoor education experiences should be provided to all teachers and can include information about the programs offered at Bernheim Forest, Blackacre, Jefferson Memorial Forest, and Falls of the Ohio. We would also recommend the incorporation of a discussion board on the internet for all JCPS teachers using outdoor education. This discussion page would provide teachers an opportunity to share their experiences, find answers, and create a support network through mutual cooperation and contributions.

Note: Contact the following schools to provide information on establishment and/or expansion of their outdoor education programs.

- Liberty High School (principal)
- Barret Traditional Middle School (principal) would like to have a presentation on what EE is and how it is implemented.
- Wellington Elementary School (principal) would like info on how to establish a program.



References

- Athman, Julie & Monroe, Martha. "The Effects of Environment-based Education on Students' Achievement Motivation." *Journal of Interpretation Research*. 9(1) 9-25. 27 April, 2008.
- Bartosh, Oksana. Environmental education: Improving student achievement. Unpublished master's thesis. 27 April 2008. http://www.pecworks.org/PEEC/PEEC_Research/0032637E-007EA7AB.3/Bartosh%202004%20EE%20improving%20student%20achievement.pdf
- "Best Management Practices: Planning First to Make Your Outdoor Classroom Last" 2004. Georgia Wildlife Federation. 3 February 2008. <http://www.gwf.org/resources/wildlifehabitats/bmpindex.html>
- Brightside. Outdoor Classrooms. Outdoor Classroom Registry. 3 Feb. 2008. <http://www.louisvilleky.gov/Brightside/Education+Programs/Outdoor+Classroom.htm>
- Broda, Herbert W. "Making the School Grounds an Outdoor Classroom." *Schoolyard-Enhanced Learning: Using the Outdoors as an Instructional Tool, K-8*. 2007. Stenhouse Publishers. 2 February 2008. http://www.stenhouse.com/assets/pdfs/Broda_Ch-02.pdf
- Duffin, Michael & Chawla, Louise. Place-Based Education and Student Achievement. 27 April 2008. http://www.pecworks.org/PEEC/PEEC_Research/S0032637E
- Falco, Edward. Environment-Based Education: Improving Attitudes and Academics for Adolescents. April 25 2008. http://www.myschools.com/Offices/CSO/enved/documents/EducationUsingtheEnvironmentFINAL2004_000.doc
- EE Grants Awarded in Kentucky. 3 February 2008. <http://www.epa.gov/enviroed/grants/KY02.htm>
- "Effects of Outdoor Education Programs for Children in California". American Institutes for Research. (27 Jan 2005)
- "Georgia Schoolyard Wildlife Habitat Planning Guide." 2006. Georgia Wildlife Federation. 3 February 2008. <http://www.gwf.org/resources/wildlifehabitats/swhguide/habitatguidelowres.pdf>
- Gwaltney, Lottie. A History of School Gardens in Louisville, Kentucky. Masters Thesis. 1951.
- Kail, Amanda. "Sustaining Outdoor Classrooms." *Green Teacher*. 2004. Georgia Wildlife Federation. 3 February 2008. www.gwf.org.
- Kenney, Jane L. "Helping Teachers to Use Their School's Backyard as an Outdoor Classroom: A Report on the Watershed Learning Center Program." *Journal of Environmental Education*. 2001. 3 February 2008. <http://web.ebscohost.com/ehost/pdf?vid=3&hid=109&sid=7f499708-671c-4706-9655-85f895fa27e8%40sessionmgr109>.
- Lieberman, Gerald A and Linda Hoody and Grace Lieberman. "California Student Assessment Project: The Effects of Environment-based Education on Student Achievement". State Education & Environmental Roundtable. March 2000.